

QER / VER / TER / MER Series Smart CO₂, VOC, Temperature and Humidity Multi-Sensors and Network Interfaces, BACnet, Modbus and LoraWan



The QER10/12/14/15, VER10/12/14/15, TER10/12/14/15 and MER10/12/14/15 Series Smart Multi-Sensors have been designed for monitoring and control CO₂, VOC, Temperature and Humidity in room spaces.

The QER10/12 series sensors are wall surface mounted. QER14/15 series controllers are Slimline flush mounted to standard wall mounting boxes.

The sensors can have an optional colour display with high hardness glass front, and/or additional PIR sensor. Touchscreen option is available for network user interface functions and interactive sensor operations such as trending. Optional Bluetooth wireless interface provides Smart Phone App interface (iOS). LoraWan option allows integration wirelessly to the LoraWan systems.

Features

- Smart Multi-Function Sensors for monitoring temperature, CO₂, VOC, humidity and passive infrared movement
- VOC calculations compliant by WELL Building Standard[®] and RESET[®] Air
- xER10/12/15 Series have 4 x Analogue 0..10Vdc Outputs, max. 2mA, for measurements and control, xER14 Series have 3 x Analogue 0..10Vdc Outputs
- xER10/12/15 Series have 2 x Universal inputs (temperature/0-10V/digital) offer application flexibility and local measurements, xER14 Series have 1 x Universal Input
- BACnet MS/TP or Modbus RS485 RTU with up to 60V industrial isolation on RS485 for system integration
- Optional 2.4" Colour Screen / Touchscreen for Alarms, Trend Graphs and User Interface Functions such as setpoint, window position overrides, operating modes, blinds and lights position control etc.
- xER10/12/ Series have Optional 24V pilot relay (RL-option) allows equipment switching locally
- xER14 Series have built-in 230Vac 5A rated relay
- xER10/12 Series have 24Vac/dc power supply, xER14/15 Series have 90-250Vac Power Supply
- With Touchscreen option Timed Boost Override for control outputs
- Can be used as BACnet/Network User Interface and I/O for BMS Systems in distributed applications (provides measurements, user overrides and system indications, hardware network inputs and outputs)

- 2 x Built-In PI Control Loops that allow local control of Temperature, Humidity, CO2, VOC or combination of them
- Bluetooth wireless connection (Smart Phone App) and LoraWan wireless communication options
- Configuration through Device Configuration Tool Software (Windows, connection via Bluetooth or USB-SERIAL) or Smart Phone iOS App (via Built-In Bluetooth or using Bluetooth Dongles)
- Available in both White and Black. The screen has number of different skin colour options for user preferences.
- User display language customisable using the language packs

Technical Specifications

Power Supply:	Power:	xER10/xER12: 24Vac/dc -10%/+15%, max 80mA with display xCR14/xCR15: 90-250VAC 50/60Hz, 0.15A
Measurements:	CO2 (QER Models)	
	Range:	0..10,000ppm
	Accuracy:	+/-50ppm + 3% of the reading
	Temperature (All Models)	
	Range:	0..50° (32..122°F)
	Accuracy:	+/-0.5°C (typical accuracy +/-0.3°C within 18-24°C)
	Humidity (Option / MER Models)	
	Range:	0..100%rH
	Accuracy:	+/-2%rH (within 20 to 80%rH)
	VOC (Volatile Organic Compound/Total Volatile Organic Compound) (Option / VER Models);	
	Range:	Air Quality Index : 0..500 TVOC Ethanol: 17..4491 ug/m ³ / 9..2383 ppb TVOC Molhave (WELL Building Standard®): 23..6621 ug/m ³ / 5..1326 ppb TVOC Isobutylene (RESET® Standard): 21..5482 ug/m ³ / 9..2389 ppb
	PIR (Option)	
	Type/Range:	Passive Infrared Occupancy/Movement Detection, Range up to 5m
Inputs:	Universal Inputs:	2 x Universal Inputs - RI/AI/DI Application Selected RI = NTC10 Measurement AI = 0..10Vdc Input DI = Digital Volt-Free Input
Outputs:	Analogue Outputs:	4 x 0..10Vdc, min. load resistance >5 kOhms (max. 2mA @ 10V)
	Relay Outputs:	xER10 (RL Option): 1 x 24V Pilot Relay, max 0.5A xER12 (RL Option): 1 x 24V Pilot Relay, max 0.5A. xER14: 1 x 230Va, max 7A (res.)
Communication:	Physical Interface	1 x RS485 driver with up to 60V industrial Isolation, recommended max 63 devices
	Protocol:	Modbus RTU or BACnet MS/TP (order relevant model)
	Addressing:	Via Bitswitch: 1..127 Via Software: 1..247 for Modbus, 1..127 for BACnet MS/TP
	Settings:	Baud Rate: 9600/19200/38400/76800 (bitswitch), 57600/115200 (software) Modbus Parity: None/Even/Odd, Modbus Stop Bits: 1 or 2 (Default: 9600/None/1)
Wireless Interface:	Bluetooth (Option):	Bluetooth Low Energy - iOS Smart Phone App Interface
	LoraWan (Option):	LoraWan® Wireless Interface (EU868, other bands available on request) Encrypted LoraWan® 1.0.3 Class C Device with secure OTAA activation with IPEX antenna for long-range communication.
Display:	LCD Option	Optional 2.4" Full Colour Display with Glass Overlay, 240 x 320px
	Touchscreen Option	Capacitive Touchscreen
Mechanical:	Wiring Terminals:	Rising Cage Screw Terminals, 0.2 to 2.5mm ² / 26 to 12 AWG
	Enclosure:	ABS ULV0 Plastics - White or Black
	Protection Class:	IP30 (when mounted on wall or a junction box)
	Mounting:	xER10: Wall or Junction Box Mounting (60mm screw distance) xER12/xER14/xER15: Junction Box Mounting (60mm screw distance)
	Dimensions	xER10: W86 x H86 x D24mm xER12/xER14/xER15: W86 x H86 x D14mm (Surface Part) W86 x H86 x D39mm (Total)
Country of Origin:		United Kingdom

Model Selection

QER10/12, MER10/12, VER10/12 AND TER10/12 24V POWER SUPPLY VERSIONS

Refer to the below table to select the required model. The part number offers descriptive method for the product and options selection, and the SKU# number provides unique reference number for the part. It is possible to order products using either.

Part Number		SKU# Number				
Example	QER10-MOD-LCD-BLE-RH-VOC-B	1000	1	04	02	00 01
Product Name		Product		Product Options		
QER10	Room CO2 and Temperature Multi-Sensor, 2UI, 4AO, 24Vac/dc Supply	1000				
MER10	Room Humidity and Temperature Multi-Sensor, 2UI, 4AO, 24 Vac/dc Supply	1100				
TER10	Smart Room Temperature Sensor, 2UI, 4AO, 24Vac/dc Supply	1200				
VER10	Room VOC, Humidity and Temperature Multi-Sensor, 2UI, 4AO, 24Vac/dc Supply	1300				
QER12	Slimline Room CO2 and Temperature Multi-Sensor, 2UI, 4AO, 24Vac/dc Supply	1020				
MER12	Slimline Room Humidity and Temperature Multi-Sensor, 2UI, 4AO, 24Vac/dc Supply	1120				
TER12	Slimline Smart Room Temperature Sensor, 2UI, 4AO, 24Vac/dc Supply	1220				
VER12	Slimline Room VOC, Humidity and Temperature Multi-Sensor, 2UI, 4AO, 24Vac/dc Supply	1320				
Communication Options						
MOD	Modbus RS485		1			
BAC	BACnet MS/TP		2			
Interface Options						
	No Interface					00
LCD	Colour Display					01
TS	Colour Capacitive Touchscreen					02
BLE	Bluetooth App Interface					03
LCD-BLE	Colour Display and Bluetooth					04
TS-BLE	Touchscreen and Bluetooth					05
LRA	LoraWan Wireless Interface, EU868Mhz					06
LCD-LRA	Colour Display and LoraWan Interface, EU868MHz					07
TS-LRA	LoraWan Wirelsss Interface EU868MHz with Touchscreen					08
Measurement Options						
	No Extra Measurements					00
RH	Relative Humidity (QER Only)					01
RH-VOC	Volatile Organic Compound and Humidity (QER Only)					02
OE	Passive Infrared Sensor (PIR)					03
RH-OE	Relative Humidity and PIR (QER Only)					04
RH-VOC-OE	VOC, Relative Humidity and PIR (QER Only)					05
Output Options						
	No Output Options					00
RL	24V Relay Output					01
Colour Options						
B	Black					01
W	White					02

QER14/15, MER14/15, VER14/15 AND TER14/15 90-250V POWER SUPPLY SLIMLINE VERSIONS

Part Number		SKU# Number				
Example	QER14-MOD-TS-B	1030	1	02	00	00
Product Name		Product	Product Options			
QER14	Slimline Room CO2 and Temperature Multi-Sensor, 1UI, 3AO, 1RO, 90-250Vac Supply	1040				
MER14	Slimline Room Humidity and Temperature Multi-Sensor, 1UI, 3AO, 1RO, 90-250Vac Supply	1140				
TER14	Slimline Smart Room Temperature Sensor, 1UI, 3AO, 1RO, 90-250Vac Supply	1240				
VER14	Slimline Room VOC, Humidity and Temperature Multi-Sensor, 1UI, 3AO, 1RO, 90-250Vac Supply	1340				
QER15	Slimline Room CO2 and Temperature Multi-Sensor, 2UI, 4AO, 90-250Vac Supply	1050				
MER15	Slimline Room Humidity and Temperature Multi-Sensor, 2UI, 4AO, 90-250Vac Supply	1150				
TER15	Slimline Smart Room Temperature Sensor, 2UI, 4AO, 90-250Vac Supply	1250				
VER15	Slimline Room VOC, Humidity and Temperature Multi-Sensor, 2UI, 4AO, 90-250Vac Supply	1350				
Communication Options						
MOD	Modbus RS485		1			
BAC	BACnet MS/TP		2			
Interface Options						
	No Interface					00
LCD	Colour Display					01
TS	Colour Capacitive Touchscreen					02
BLE	Bluetooth App Interface					03
LCD-BLE	Colour Display and Bluetooth					04
TS-BLE	Touchscreen and Bluetooth					05
LRA	LoraWan Wireless Interface, EU868Mhz					06
LCD-LRA	Colour Display and LoraWan Interface, EU868MHz					07
TS-LRA	LoraWan Wirelss Interface EU868MHz with Touchscreen					08
Measurement Options						
	No Extra Measurements					00
RH	Relative Humidity (QER Only)					01
RH-VOC	Volatile Organic Compound and Humidity (QER Only)					02
OE	Passive Infrared Sensor (PIR)					03
RH-OE	Relative Humidity and PIR (QER Only)					04
RH-VOC-OE	VOC, Relative Humidity and PIR (QER Only)					05
Colour Options						
B	Black					00 01
W	White					00 02

Wiring Connections

QER10, MER10, VER10 AND TER10 (xER10) WIRING

The diagram below illustrates the wiring connections to the sensors.

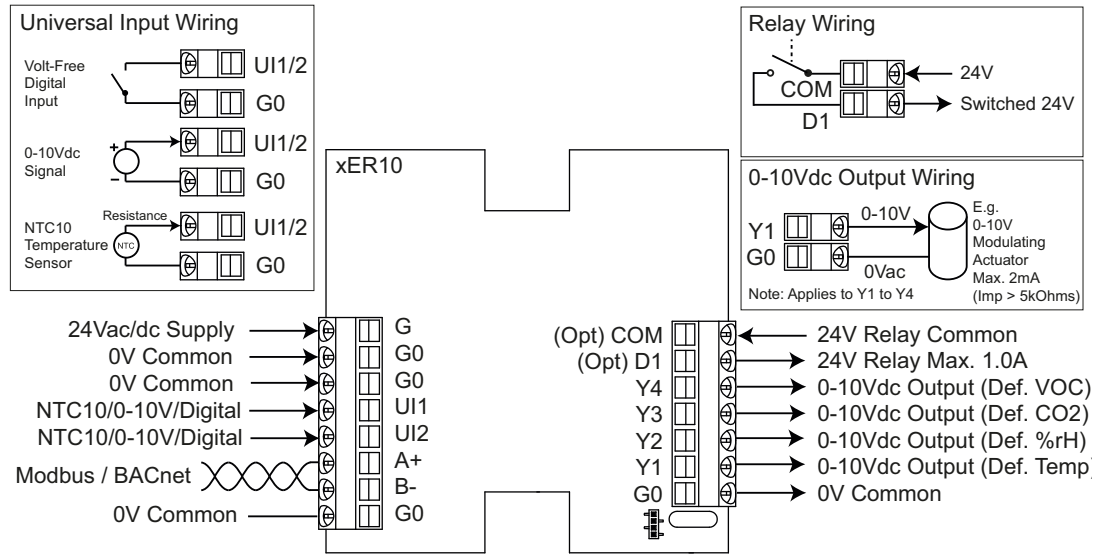

Terminal	Description
G	24Vac/dc -10/+15% Supply
G0	0V Common
UI1	NTC10/0-10V/Volt-Free Digital Input 1
UI2	NTC10/0-10V/Volt-Free Digital Input 2
A+	Modbus / BACnet RS485 A+
B-	Modbus / BACnet RS485 B-
G0	0V Common

Terminal	Description
COM	24V Relay Common (Option)
D1	24V Relay Max 1.0A (Option)
Y4	0-10Vdc Output max. 2mA - Default: VOC
Y3	0-10Vdc Output max. 2mA - Def: CO2
Y2	0-10Vdc Output max. 2mA - Def: Humidity
Y1	0-10Vdc Output max. 2mA - Def: Temperature
G0	0V Common

QER12, MER12, VER12 AND TER12 (xER12) SLIMLINE WIRING

xER12 series Smart sensors are flush mounted to junction box. The diagrams below illustrate the wiring.

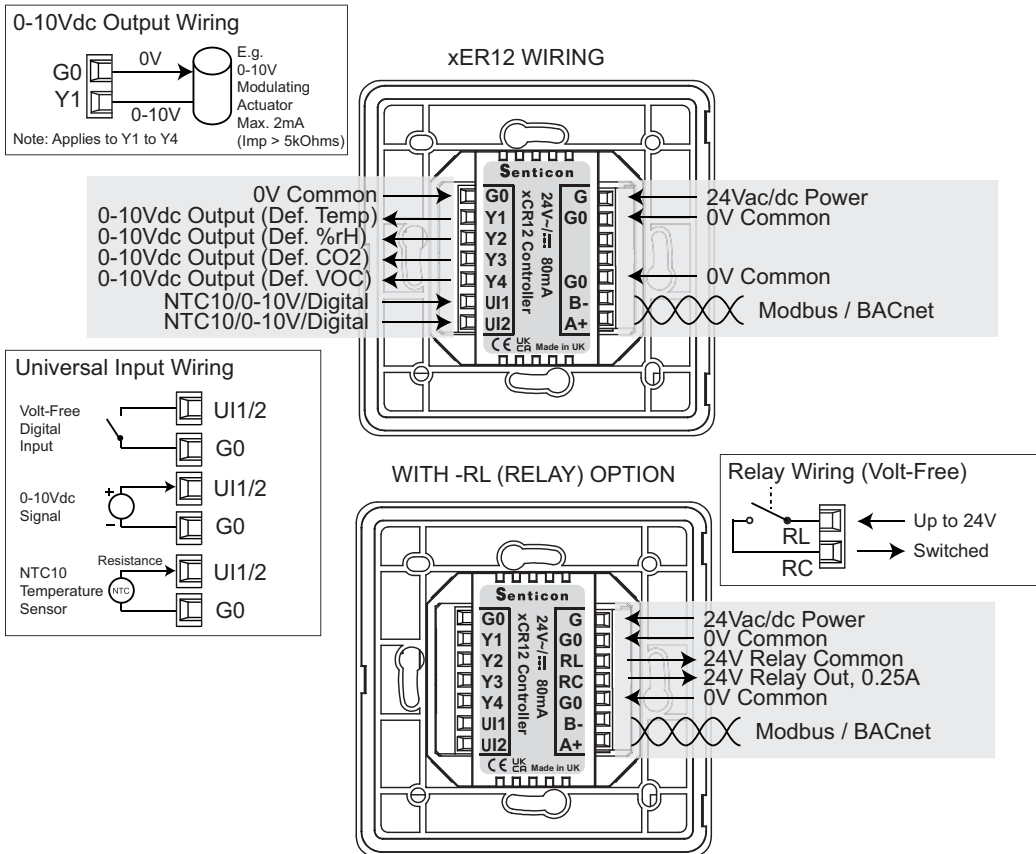

Terminal	Description
G0	0V Common
Y1	0-10Vdc Output 1, max. 2mA (Default: Heating Stage 1)
Y2	0-10Vdc Output 2, max. 2mA (Default: Cooling Stage 1)
Y3	0-10Vdc Output 3, max. 2mA (Default: EC Fan Speed)
Y4	0-10Vdc Output 4, max. 2mA (Default: CO2 Control)
UI1	NTC10/0-10V/Volt-Free Digital Input 1
UI2	NTC10/0-10V/Volt-Free Digital Input 2

Terminal	Description
G	24Vac/dc -10/+15% Supply Note: Triacs need 24Vac
G0	0V Common
RL	24V Relay (RL-option)
RC	24V Relay Common (RL-option)
G0	0V Common
B-	Modbus / BACnet RS485 B-
A+	Modbus / BACnet RS485 A+

QER14, MER14, VER14 AND TER14 (xER14) SLIMLINE 90-250V WIRING

xER14 series Smart sensors are flush mounted to junction box and have 90-250Vac power supply. The devices have built-in 230Vac relay output. The diagrams below illustrate the wiring.

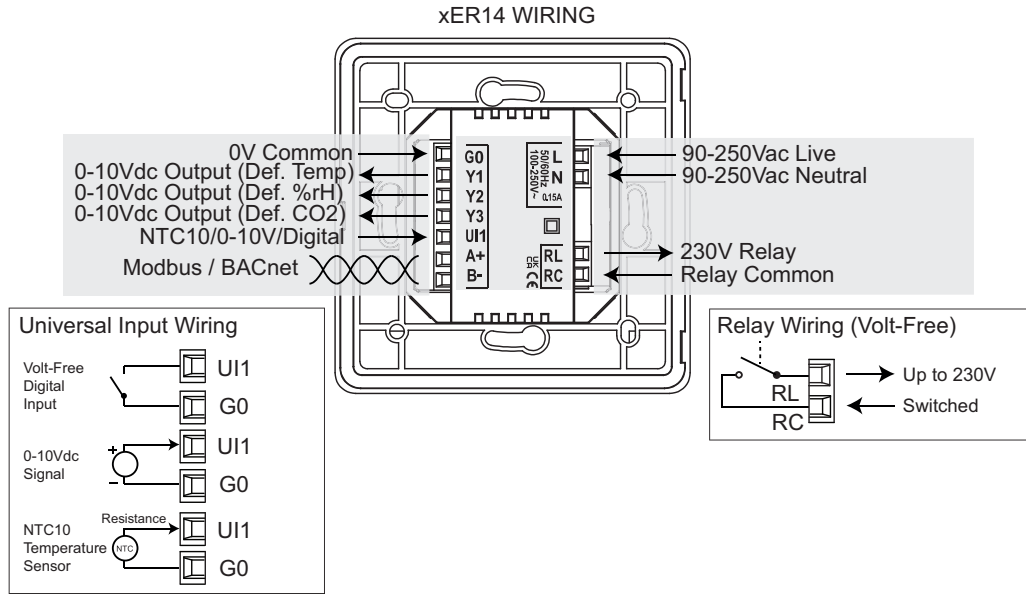

Terminal	Description
G0	0V Common
Y1	0-10Vdc Output 1, max. 2mA (Default: Heating Stage 1)
Y2	0-10Vdc Output 2, max. 2mA (Default: Cooling Stage 1)
Y3	0-10Vdc Output 3, max. 2mA (Default: EC Fan Speed)
UI1	NTC10/0-10V/Volt-Free Digital Input 1
A+	Modbus / BACnet RS485 A+
B-	Modbus / BACnet RS485 B-

Terminal	Description
L	90-250Vac Live, 50/60Hz
N	90-250Vac Neutral, 50/60Hz
RL	Relay Out, 230Vac, max 7A (res.)
RC	Relay Common, max. 230Vac

QER15, MER15, VER15 AND TER15 (xER15) SLIMLINE 90-250V WIRING

xER15 series Smart sensors are flush mounted to junction box and have 90-250Vac power supply. The diagrams below illustrate the wiring.

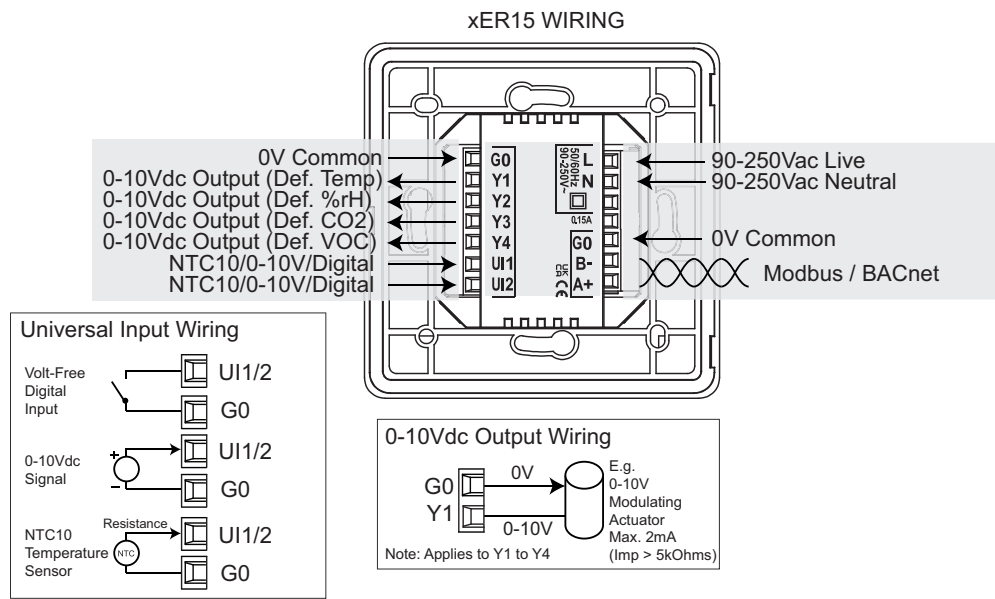

Terminal	Description
G0	0V Common
Y1	0-10Vdc Output 1, max. 2mA (Default: Heating Stage 1)
Y2	0-10Vdc Output 2, max. 2mA (Default: Cooling Stage 1)
Y3	0-10Vdc Output 3, max. 2mA (Default: EC Fan Speed)
Y4	0-10Vdc Output 4, max. 2mA (Default: CO2 Control)
UI1	NTC10/0-10V/Volt-Free Digital Input 1
UI2	NTC10/0-10V/Volt-Free Digital Input 2

Terminal	Description
L	90-250Vac Live, 50/60Hz
N	90-250Vac Neutral, 50/60Hz
G0	0V Common
B-	Modbus / BACnet RS485 B-
A+	Modbus / BACnet RS485 A+

WIRING GUIDELINES

In order to wire the device, remove the front cover by pressing the clip on the bottom of the display e.g. using a flat headed screwdriver. Be careful not to use excess force. Whilst pressing the clip lift the front cover from the bottom edges of the enclosure.

Make sure that power is switched off and carry out wiring according to the wiring connections drawing and local wiring guidelines. Insert the front cover and power up the device.

NOTE: For opening and mounting the enclosure please refer to the Dimensions and Installation Chapter.

Measurements

CO2 (CARBON DIOXIDE) MEASUREMENT (QER MODELS)

CO2 (Carbon Dioxide) measurement is available through the analogue outputs Y1 to Y4 as proportional 0..10Vdc signal. As default Y3 has been configured for CO2 reading. The measurement is also available via Modbus and BACnet communication network.

The output signal is scaled as default 400..2,000ppm = 0..10Vdc. The output scaling can be modified by changing the min/max scaled CO2 parameters. The maximum scaling is the full range of the CO2 sensor (10,000ppm).

The CO2 sensor provides Automatic Self Calibration logic keeping the measurements accurate over the time.

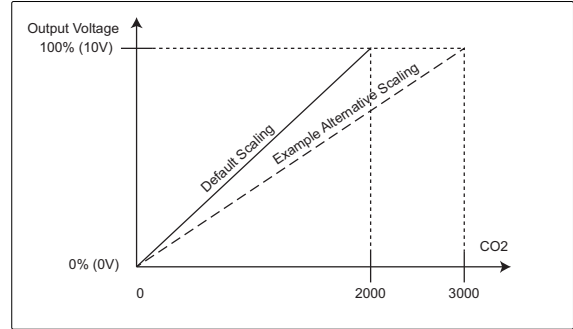

TEMPERATURE MEASUREMENT (ALL MODELS)

Temperature measurement is available through the analogue outputs Y1 to Y4 as proportional 0..10Vdc signal. As default Y1 has been configured for temperature. The measurement is also available via Modbus and BACnet communication network.

The output signal is scaled as default 0..50°C (32..122°F) = 0..10Vdc. The output scaling can be modified by changing the min/max scaled temperature parameters.

NOTE: For accurate temperature measurement it is important that correct installation instructions are followed - see Dimensions and Installation Chapter.

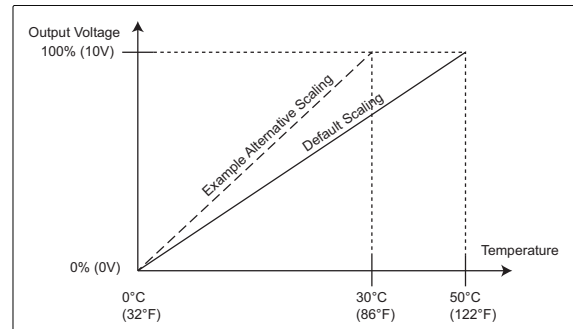

HUMIDITY MEASUREMENT (MER MODELS / OPTION)

Humidity measurement is available through the analogue outputs Y1 to Y4 as proportional 0..10Vdc signal. As default Y2 has been configured for relative humidity. The measurement is also available via Modbus and BACnet communication network.

The output signal is scaled as default 0..100%rH = 0..10Vdc. The output scaling can be modified by changing the min/max scaled humidity parameter.

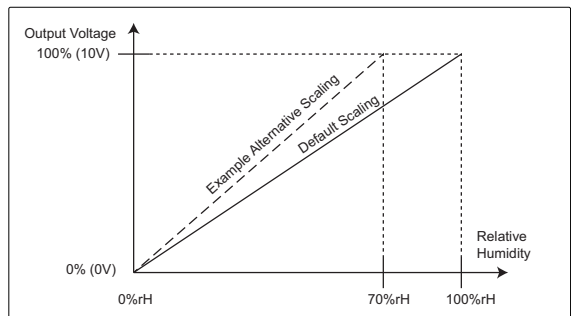

MOVEMENT DETECTION USING PASSIVE INFRARED SENSOR (OPTION)

The sensors can be fitted with an optional pyroelectric infrared motion sensor for the occupancy and movement detection. The sensor element is designed for optimal usability and reliability with low power consumption, better sensitivity and signal-to-noise ratio reducing the false detections.

The movement sensor status is available over the network or through the optional relay output.

The diagram illustrates the detection area.

The movement sensor *Delay Off Timer* (10..28,800 seconds) parameter sets the time that the status latches ON after detection of movement.

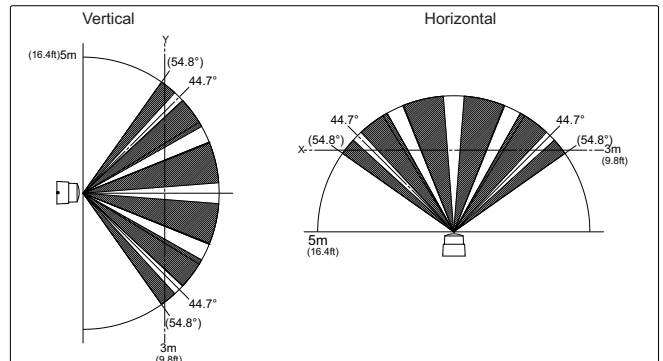

NOTE: Any new detected movement resets the timer. The movement sensor has 30 seconds warm-up delay on power up.

RH-VOC VOLATILE ORGANIC COMPOUND MEASUREMENT (VER MODELS / OPTION)

The VOC sensor option measures Volatile Organic Compounds with automatic humidity compensation providing relative indoor air quality index signal (see below diagram). The measurement can be outputted to 0..10Vdc output and read over Modbus/BACnet communication network.

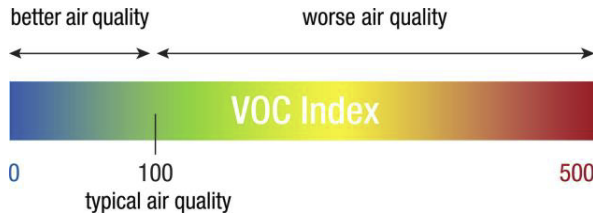

Measured air pollutants include harmful gases (acetone from paints and glues, toluene from furniture, mattresses and building products), other gases (ethanol from alcohol, perfumes and cleaners), odours (hydrogen sulfide and volatile sulfuric compounds from rotten food and farts; ammonia and amines from pet urine), smoke (benzene and nitrosamines from cigarette smoke).

The output signal is scaled as 0..500 index = 0..10Vdc.

TVOC Ethanol Concentration Calculation

The xER10 Series Sensors can calculate and display TVOC_{Ethanol} by selecting *VOC Measurement Mode/ TVOC Ethanol* from the *Calibration and VOC Mode Settings* Menu. TVOC_{Ethanol} setting provides Total Volatile Organic Compounds (ppb - parts per billion) with Ethanol as the reference gas. The maximum value is 2383 ppb (or 4491 ug/m³).

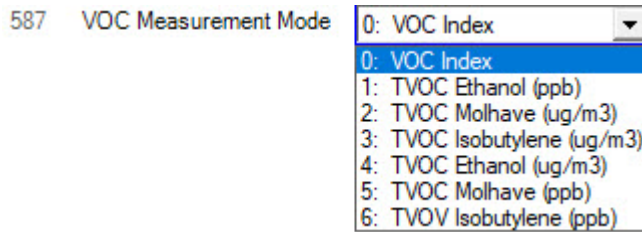

WELL Building Standard® Compliant TVOC Concentration

According to the Performance Guidebook v.2 of the WELL Building Standard®, performance of an IAQ monitor can be assessed by using ethanol as calibration gas and the Molhave gas mixture to convert the ethanol concentration into the Molhave equivalent of TVOC or TVOC_{Molhave}. The xER10 Series Sensors can calculate and display TVOC_{Molhave} by selecting *587 VOC Measurement Mode = TVOC Molhave* from the *Calibration and VOC Mode Settings* Menu. Two options for both ppb and ug/m³ calculation are available. The maximum value is 1321 ppb (or 5482 ug/m³).

Now Parameter *403 VOC Sensor (index)* shows the TVOC concentration based on the TVOC_{Molhave} index. .

RESET® Air compliant TVOC concentration

The xER10 Series Sensors can calculate and display TVOC_{Isobutylene} by selecting *VOC Measurement Mode/TVOC Isobutylene* from the *Calibration and VOC Mode Settings* Menu. TVOC_{Isobutylene} setting provides RESET® Air compliant TVOC concentration. Two options for both ppb and ug/m³ calculation are available. The maximum value is 2389 ppb (or 5482 ug/m³).

NOTE: The 589: *VOC Learning Time Offset* parameter defines over what time span the VOC algorithm builds and updates its internal baseline (offset) from recent sensor history. Set to 720 for Building Standards (Reset/Well).

Universal Inputs

The sensors have two Universal Inputs. The universal inputs can be configured to operate as NCT10 (resistive), Analogue (0..10V), Digital Binary On/Off or resistive (kOhms). The NTC10 and 0-10V measurements are available as network values or can be displayed on the screen. The Digital Binary inputs can be used to control the relay (RL option), or as network indication.

If the Universal Input is configured as 0..10V (0..100%), then the input voltage can be scaled to the measurement values using *UI Scale Min.* and *UI Scale Max.* parameters.

The maximum 0..10V measurement range is 0..3000. If the device connected to 0..10V inputs use wider range, it can also be configured using voltage clamping parameters (within the measurement range 0..3000).

Examples of the typical settings are showed on the table below.

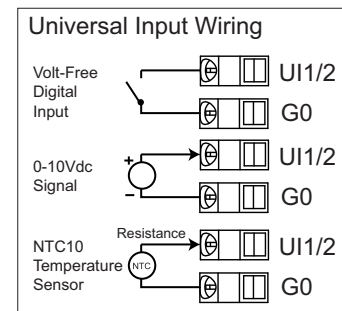

Connected Device Output Voltage	Connected Device Measurement	Universal Input Measurement	Universal Input Settings (See Input/Output Settings parameters for further info)
0..10V	0..100%	0..100%	Default Settings
0..10V	0..50 degree	0..50 degree	Default Settings + UI Scale Max. = 50.0
0..10V	0..2000ppm	0..2000ppm	Default Settings + UI Scale Max. = 2000.0
0..10V	400..2000ppm	400..2000ppm	Default Settings + UI Scale Min. = 400.0; UI Scale Max. = 2000
0..10V	0..5000ppm	0..3000ppm	Default Settings + UI Scale Max. = 2000; UI Voltage Max. = 6.0V

Analogue Outputs

The sensors have 4 x 0..10Vdc outputs. The Y1/Y2/Y3/Y4 0..10V outputs can be configured to transmit the temperature, humidity, VOC, CO2 and UI measurements. In addition the outputs can be configured for Control Loop output and for Max Loop1/Loop2 outputs (see Control Loops chapter for further details).

The temperature, humidity, VOC and CO2 measurement outputs can be scaled using Min/Max scaling parameters.

The outputs can be also configured giving 0-10Vdc setpoint signal. Using the touchscreen model the device can be used e.g. as setpoint adjuster, window position adjusted, blinds position adjuster or light level adjuster.

The outputs can also be controlled from the Modbus/BACnet network.

If the analogue output is configured for the Universal Input measurement, the output voltage depends on the Input configuration. In case of the NTC10, the 0..10V output is scaled based on the Min/Max. Scaled Temperature. If 0..10V input option is selected, the input voltage is transmitted to the output directly. In case of digital mode, the output voltage is 0V when input is OFF and the output voltage is 10V when the input is ON.

Relay Output (RL-Option)

The sensors can have optional 24V relay output. The relay contacts are volt-free. The relay can be controlled from the network, transmit UI or PIR status, or used for control (see Relay Output Control section for further details).

Colour Display and Capacitive Touchscreen Options

The sensors can have optional full colour 240 x 320 pixel high resolution glass fronted display. The display can be used to indicate the current measurements and indicate alarm conditions. Additional capacitive touchscreen option allows the users to interact with the system.

COLOUR DISPLAY OPTION (-LCD)

The colour display has been designed to display measurements in up to 5 locations. Each of the locations can be individually configured according to the requirements. In addition status bar on the top of the display can be used to indicate system conditions (status of the built-in PIR or BMS can send display commands via Modbus/BACnet network).

Each of the five display locations can be configured to show

- CO2, VOC, Temperature, or Humidity Measurement
- Universal Input Measurements (0..10Vdc or NTC10)
- Locations 2-5 can show Digital Input status as Text (Default: On/Off)
- Network Signals (e.g. Energy, Water Consumption, Pressure, Light Level Signals, Light On/Off Indication)
- Alarm Conditions of the Measurements (Green, Amber, Red)
- Descriptive Text instead of Measurement Value (Low / Normal / High)

The display can be furthermore customised to:-

- Change the resolution of the temperature display; Fine (0.1°C/0.1°F), Normal (0.5°C/0.5°F), and Coarse (1°C/1°F). Please note Humidity, CO2 and VOC are displayed with resolution of one integer.
- To show fan speed and movement (PIR) status (Modbus/BACnet signals from the BMS)
- The description and units of each location can be customised
- The skin colour of the display can be changed according to the preference; White, Blue, Green, Grey and Black
- Brightness of the display can be adjusted
- Using Language Pack it is possible to change the text language

-LCD DISPLAY
BLACK COLOUR



-LCD DISPLAY
BLUE COLOUR

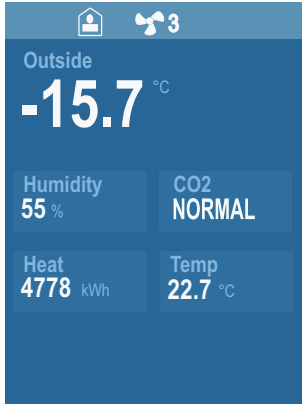

-LCD DISPLAY
GREEN COLOUR

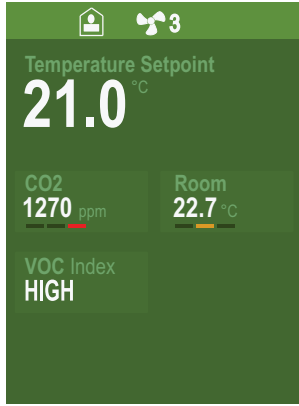

-LCD DISPLAY
WHITE COLOUR

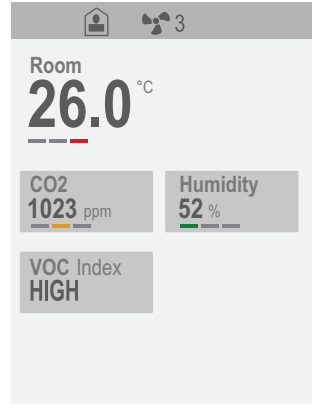

-LCD DISPLAY
GREY COLOUR

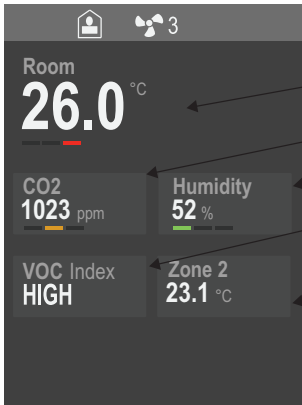

- Fan Speed Indication (Network or Local Button)
- Occupancy Indication (PIR or Network)
- Alarm Indication (Measurement or Network Signal)
- Up to 4 Display Locations to Show Measurements
- Descriptive Text Indication (Low / Normal / High)
- Energy Measurement Indication
- Water Consumption Indication

TRAFFIC LIGHT ALARM FUNCTION

Each of the 5 locations can be activated to display alarm condition based on the Amber and Red Limits. When measurement is above the Amber Limit, the location goes to Amber alarm (amber bar icon, or amber skin colour). When measurement is above the Red Limit, the location goes to Red Alarm (red bar icon or red skin colour).

ALARMING USING BAR DISPLAY

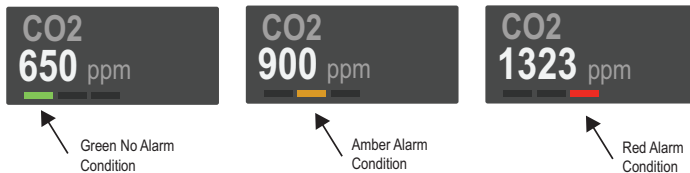

ALARMING USING SKIN COLOUR

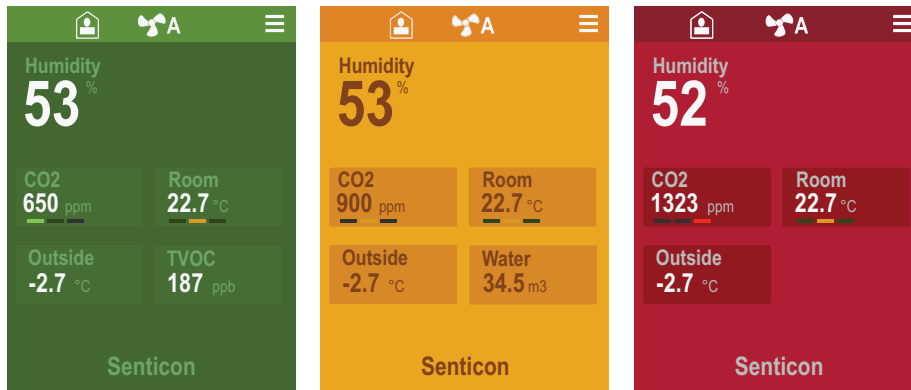

Green No Alarm Condition (Set display colour to green)

Amber Alarm Condition

Red Alarm Condition

CAPACITIVE COLOUR TOUCHSCREEN OPTION (-TS)

With the capacitive touchscreen option the display becomes interactive to the users. The capacitive touchscreen offers an accurate touch capability to the room sensors.

NOTE: All features mentioned in the LCD model section above are also available with the TS models.

With touchscreen the following additional user interface options become available.

- Boost button with an adjustable timer
- Setpoint adjustment option for any of the four (5) locations - max. 2 setpoints
- Locations 2 to 5 can have On/Off button (set to Read Only for indication only)
- Window/blinds position adjustment and light level adjustment
- Fan speed adjustment option (A - 0 - 1 - 2 - 3)
- Two historical trend (data logging) functions - Note. Data stored in volatile memory only
- The access to each of the five (5) locations can be configured as Read/Write, Read Only or Read/Write-NoLock

Furthermore the status bar will have menu option, that allows

- The display to be dimmed
- The display to be locked from unauthorised access
- Access to the Configuration Menu (network settings)

TOUCHSCREEN DISPLAY (SKIN COLOUR SELECTABLE)

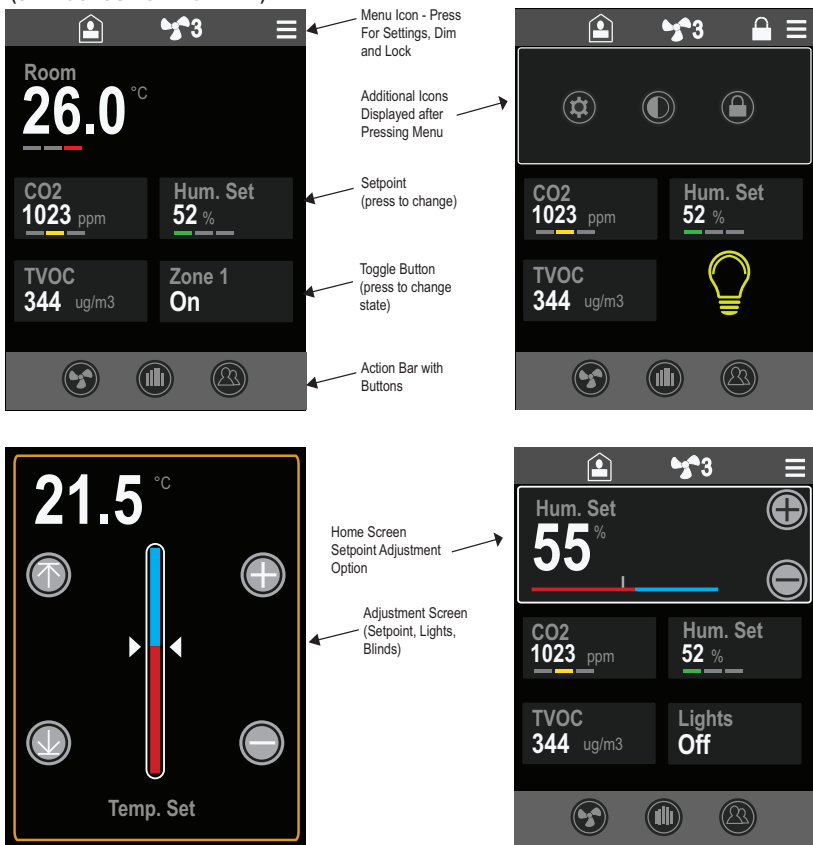

Touchscreen Provides Additional Functionality to the LCD Display

- Menu Icon (Access to settings, screen lock and dimming)
- Fan Speed Selection Button
- Historical Logging Button
- Boost (Timed) Button
- Access to Configuration
- Button to Dim (no backlight)
- Button to Lock Screen (no access)
- Status Bar - Screen Locked
- Zone 1 On / Zone 1 Off Toggle Button (Configurable Text)
- Lights Icon / Button
- Blinds / Windows Icon / Button

SETPOINT ADJUSTMENT

Two setpoint adjustments can be set to any of the five display locations. The setpoints can be configured to operate with decimal point (e.g. temperature) or with integer (e.g. CO2) accuracy. Each setpoint can have minimum and maximum adjustment limits for the user. The adjustment steps (resolution) can also be controlled. The nominal (initial) setpoint can be set from the network.

The setpoint can be shown on the home screen or on a separate setpoint adjustment screen by enabling Parameter 608 : *Setpoint Slider Screen*.

SETPOINT SLIDER SCREEN (DEFAULT)



Use top and down buttons to set immediately to min/max levels

Use touchscreen to slide the setpoint up and down

Use Plus and Minus buttons to adjust the setpoint. Press long for repeat adjustment

ALTERNATIVE SETPOINT VIEW

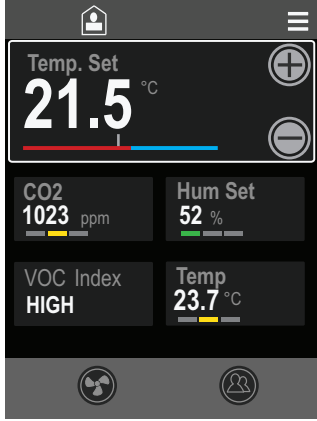

Alternative Setpoint Adjustment View displayed on the main screen (Set parameter 608 Setpoint Slider Screen = 0: Disabled to activate)

RELATIVE SETPOINT ADJUSTMENT

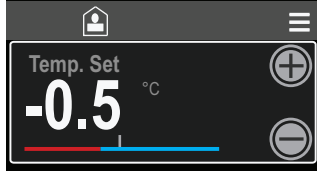

It is possible to show the relative user setpoint adjustment instead of the actual setpoint

LIGHT LEVEL ADJUSTMENT

Enabling Lights option for DisplayLocations 2 to 4 (Parameters 617/624/631/638), the Smart Room Sensor can be used for Lights Level adjustment. In the selected location on the home screen the light icon is yellow when lights level is set > 0% and in grey when the lights are switched off.

When the Lights icon is pressed, the Light Level adjustment screen is displayed (if the number of steps is configured 3 or more through parameter 682). By pressing the +/- buttons the Lights level can be incremented in steps. Pressing top and down icons the levels can be immediately set to 100% and 0%, respectively. As default the lights icon has been configured as an On/Off toggle button and it is set to 100% (On) on controller reset/power up.

The lights level can be read (and set) from Modbus/LoraWan parameter 680 and BACnet AV(14) object. It is also possible to configure the 0-10Vdc outputs to set the lights level on e.g. lighting ballasts.

SCREEN EXAMPLE

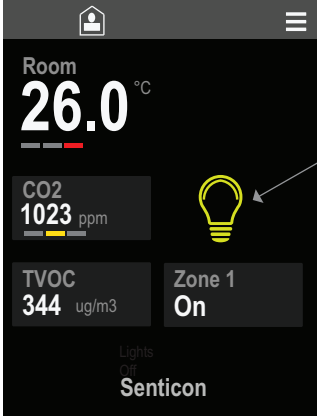

Press Light Icon to adjust Light Level

LIGHT LEVEL ADJUSTMENT

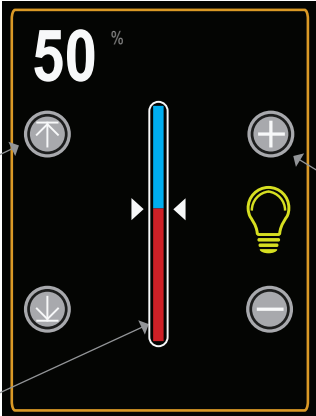

Use top and down buttons to set lights to 100% and Off.

Use Plus and Minus buttons to adjust the light level in increments. Keep pressing for continuous adjustment.

Use touchscreen to slide light level up and down

BLINDS AND WINDOW ADJUSTMENT

Enabling Blinds/Window option for Display Locations 2 to 4 (Parameters 617/624/631/638), the Smart Room Sensor can be used for the Blinds/Window Level adjustment. In the selected location on the home screen the blinds icon indicates if the blinds/windows are fully open or closed.

When the Blinds/Window icon is pressed, the Blind/Window Level adjustment screen is displayed (if number of steps is set to 3 or more through parameter 683). By pressing the +/- buttons the Blinds level/Window opening can be incremented in steps. Pressing top and down icons the levels can be immediately set to 100% and 0%, respectively. As default the Blinds / Window icon has been configured as Off/On (0/100%) toggle button.

The blinds level/window opening can be read (and set) from Modbus/LoraWan parameter 681 and BACnet AV(15) object. It is also possible to configure the 0-10Vdc outputs to set the blinds level to control the blinds / window position directly.

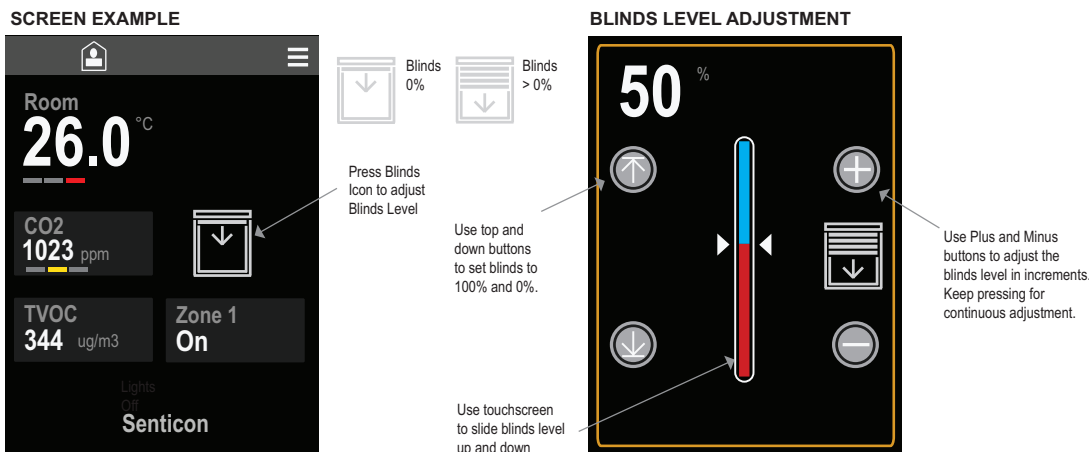

ON/OFF TOGGLE BUTTON

Locations 2 to 5 can have On/Off toggle button (from Fw 1.45 onwards).

The button status is read from the network (BACnet/Modbus/LoraWan) and can be overridden. The text 'On/Off' can be customised using Language Translation utility to say e.g. 'Heat/Cool' or 'Open/Close'.

TOGGLE BUTTON (Default States)

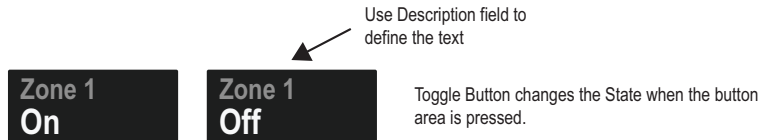

TOGGLE BUTTON (Custom Text)



FAN SPEED ADJUSTMENT

By pressing the Fan button the fan speed adjustment options are displayed on the bottom Action Bar - select the required speed. The number of fan speeds is configurable. The current fan speed is displayed on the status bar on the top.

The Fan Speed button activation and number of fan speeds can be selected through the configuration parameters.

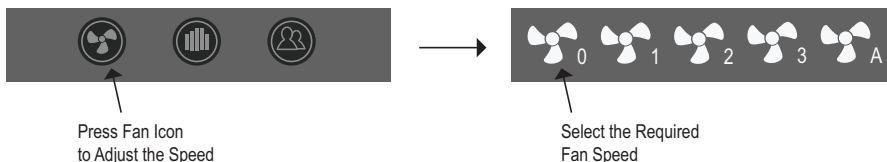

BOOST BUTTON (TIMED)

Pressing the Boost Button the device switches to Occupied Mode - Button Colour Changes and the Occupancy Icon on the Status Bar (if activated) indicates occupancy. The boost button has adjustable timer between 0..28,800 seconds. By setting boost time to 0 seconds, the Boost is permanent. The boost can be cancelled by pressing the boost button again.

The boost button and the boost time is activated through the configuration parameters.

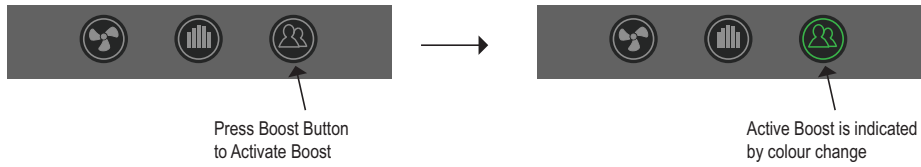

It is also possible to set the boost target to one of the control loop outputs (which can be linked to any of the analogue outputs or to the relay output). When the boost is active the output is set fully on to 100%.

HISTORICAL TREND LOGGING

If the historical logging function has been activated the Action Bar shows the Button to Access the historical log data. The history function will automatically log all measurements. It is possible to configure one or two history logs displayed on the screen. Once on the screen the different measurements can be selected by pressing the buttons for comparison. The historical logging interval can be configured between from the selectable options; 10 seconds, 30 seconds, 1 minute, 3 minutes, 30 minutes, 90 minutes.

Up to 240 historical logging samples per measurement are stored in the volatile memory (Note. The historical logs are not stored during the power off). The table below illustrates the maximum data period for each logging interval setting.

Logging Interval	Maximum Data Period
10 Second	40 minutes
30 seconds	120 minutes - 2 hours
1 minute	240 minutes - 4 hours
3 minutes	720 minutes - 12 hours
30 minutes	120 hours - 5 days
90 minutes	360 hours - 15 days

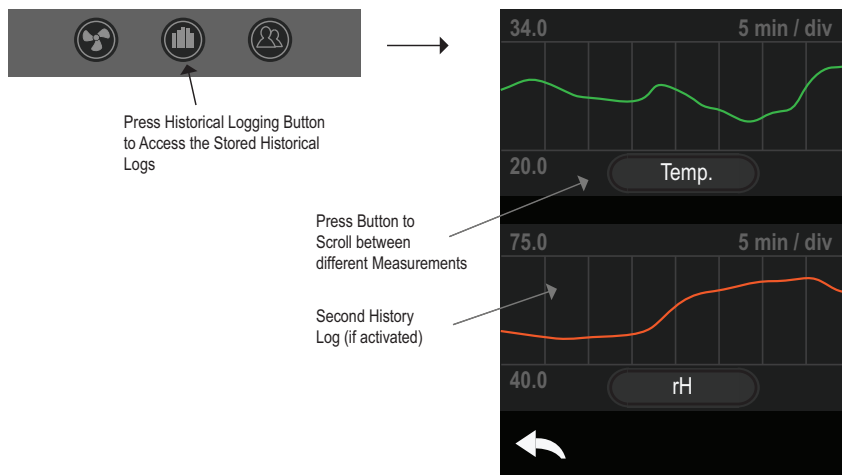

SCREEN LOCK

By selecting the Lock icon from the menu bar the screen is locked (buttons disabled, except menu and lock icons). If the Lock code is 0000, no code is required to lock and unlock the screen. By setting the lock code to any other value, the user needs to enter the code to lock and unlock the screen. From Fw1.63 screen can also be automatically locked after 3 minute timeout by setting parameter 656 *Screen Autolock: 1=Enabled*. Timeout starts counting down from the unlocking of the screen.

Note: The screen can also be locked and unlocked over the Modbus or BACnet network.

Note: Each of the five (5) locations can con be configured to be Read-Only, Read/Write and Read-Write-NoLock. If the location is configured as Read-Write-NoLock the location is active even when the screen is locked (ie. setpoint, blinds icon, on/off button, lights icon).

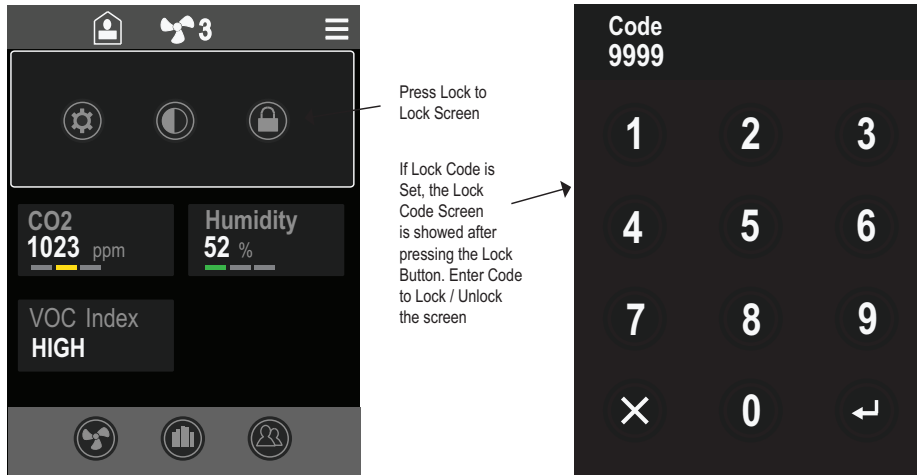

CONFIGURATION SCREEN

To access the Configuration Screen (for network settings), Press the Configuration Icon. If the configuration code is set, default 8000, the Network Settings Configuration Menu is displayed. If the code is set to 0000 then no passcode is required. To store the new configuration settings in the Non Volatile memory press the back arrow to return to the main screen.

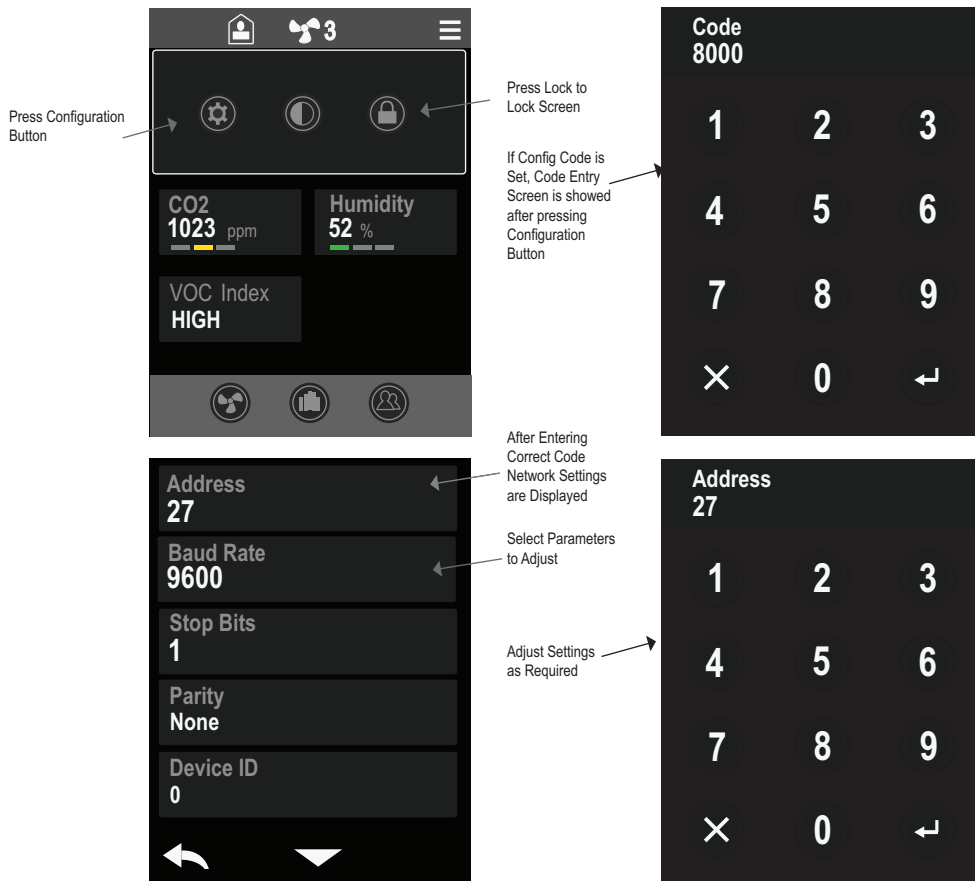

Control Functions

RELAY OUTPUT CONTROL (RL OPTION)

The devices can be fitted with additional relay (-RL option). Using the relay it is possible to switch system on/off based on the configured switching points and selected measurement. E.g. relay can be switched ON/OFF based on the CO2 reading. For available options please see the Sensor Configuration parameters.

NOTE: By reversing the switching points the relay operation is reversed.

CONTROL LOOPS (ALL MODELS)

The devices have two PI (Proportional + Integral) control loops that can be configured to control temperature, humidity, CO2 or VOC. The control loops can operate as in reverse or direct mode. In reverse mode when the measurement e.g. temperature drops from the setpoint, the control loop output will increase based on the proportional band and integral action settings. If integral action is disabled the control output increases proportionally (image below illustrates this).

In direct mode when the measurement e.g. CO2 increases above the setpoint the control output also proportionally increases base on the proportional band (and integral action) settings.

The control loop outputs can be linked to any of the analogue outputs. The output of two control loops can be combined by selecting Max Loop 1 and Loop 2 setting. This can be useful in cases where e.g. supply air flow is required to be controlled both by temperature and air quality level, or by both CO2 and VOC..

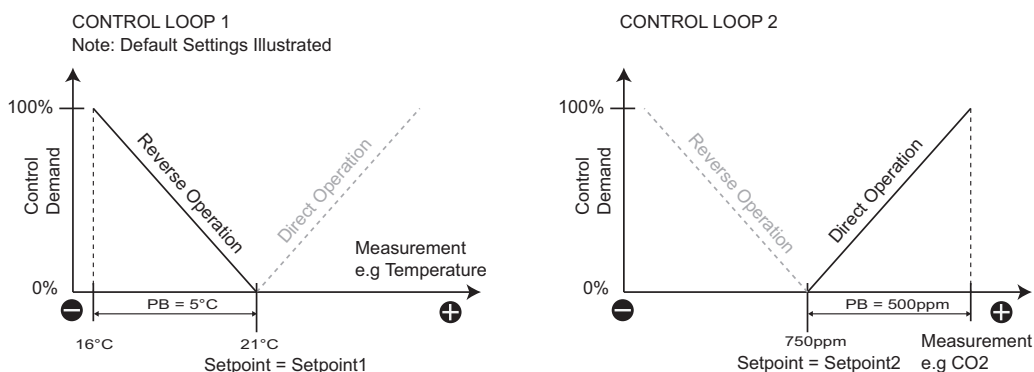

NOTE: The control outputs can also be boosted for a set period by the boost button (with TS models).

Wireless Interfaces

BLUETOOTH WIRELESS INTERFACE

With the -BLE option the devices are fitted with integrated Bluetooth Low Energy. The Bluetooth interface provides wireless connection point to SmartPhone app (iOS) to be able to interrogate and change the controller settings. Using the SmartView application the end users can change the device settings and see the current measurements. The SmartView application can be used as a complement to the display, or with non-display versions it can be used as the user interface.

NOTE: The SmartView application uses the device's display configuration to create the user view. If the device has no display, the display configuration settings can still be used to customise the user views on the App.



NOTE:With SmartConfig app you can change the devices Bluetooth name. This is also visible via the touchscreen through configuration menu (from Fw1.47).

LORAWAN® WIRELESS INTERFACE

With the -LRA option the devices are fitted with LoraWan® interface. The LoraWan® interface allows the devices to be connected to the LoraWan system wirelessly using Senticon's standard payload format.

The LoraWan® enabled devices will automatically connect to the network on power up. The connection attempts are staggered automatically based on the device serial number to ensure network performance on large systems. The devices will automatically send the device information (temperature, humidity, CO2, VOC, input and output levels and setpoints) on Senticon's Standard Payload format (up to 12 values) on scheduled intervals (1 to 60 minutes, default 10 minutes). The content of the payload message can be configured to include any smart sensor parameter. It is also possible to write to any parameter on the device using Senticon's packaged write message - please refer to Senticon LoraWan Payload Specification for further details.



LoraWan network settings can be adjusted for maximised wireless network performance. These settings include Transmission interval, Confirmed Message Interval, Number of Failed Uplink Messages, Burst Reconnect Mode and ADR disable.

Device Setup and Modbus/BACnet Communications

The devices are available with Modbus RTU or BACnet MS/TP communication for system integration. Please also note that the devices can be configured via Modbus or via BACnet MS/TP. Alternatively the devices can be configured locally using via PC Based Smart Config Tool or via iOS Smart Phone Application. Using any of these methods the device settings can be altered to suit the site requirements and the current device status can be interrogated.

Modbus and BACnet communication is carried out over RS485 serial network.

The Windows Smart Config Tool and iOS Smart Phone Application are connected to the device using Bluetooth dongle set (part no BLE-TOOLSET) that are plugged into the PC USB port and to the device (connection to device illustrated below). If the device is supplied with Built-In Bluetooth App interface (an option), then this can also be used for the tool communication connection. The SmartConfig PC tool can also be connected using USB-SERIAL cable to the devices.

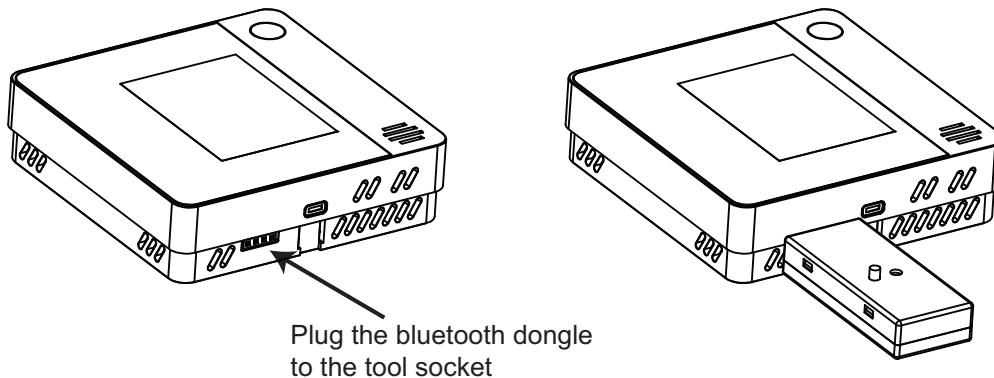

MODBUS / BACNET NETWORK SETUP

NOTE: Modbus RS485 or BACnet MS/TP versions are hardware specific models. It is not possible to change the communication protocol on the device. Please make sure to order the required model.

The devices can operate either as Modbus RTU RS485 slave device, or BACnet MS/TP Server. The device (slave/MAC) address and baud rate are set up using bit switches or through Windows Smart Configuration Tool / iOS Smart Phone App.

Bit switches 1-7 act as a binary decoder to set the (slave/MAC) address. Set these bitswitches to OFF position if the address is configured by the software.

Bit switches 8 and 9 are used to set the baud rate. Set these bit switches to OFF position if the baud rate is configured by the software.

Bit switch EOL is used to activate 120 Ohm RS485 network End of Line termination (only used on the end of line devices).

NOTE: Once bit switches are changed the device will automatically carry out soft reset to activate the new settings.

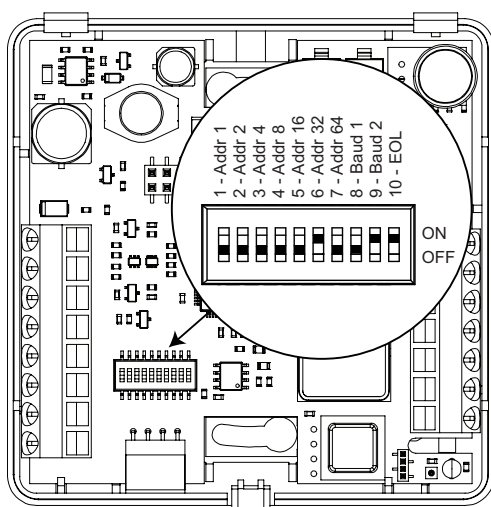

Baud Rate Setup

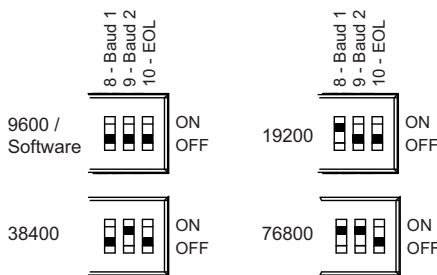

Address Setup Example

Bit switches 1 - 7 with binary decoding set the address. E.g.
Address 19 = Bit switches 1, 2 and 5 ON
(1 + 2 + 16 = 19)

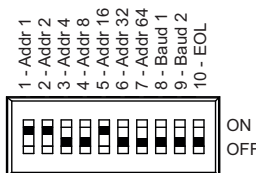

NOTE: Please note that Modbus register addresses start with 0 (0-based). If your Modbus master addresses start from one (1), then you will need to add one to the register values on the below table. If your Modbus master uses zero based addressing then the registers can be used as is.

NOTE: BACnet configuration parameter addresses are split to multiple Device Configuration objects.

NOTE: *) Reg Field shows the Modbus register offset. The Reg field is also used with BACnet Device Configuration Objects.

NOTE: If the configuration parameters are changed over the Modbus or BACnet using third party tools usch as Modbus clients or Yabe for BACnet, please ensure that System Parameter 811 - Persist is applied after the configuration to store the new settings permanently.

LIVE DATA						
		MODBUS INPUT REGISTERS - FUNCTION CODE 04 MODBUS HOLDING REGISTER - FUNCTION CODES 03, (06), 16				
Parameter	Description	Reg	Type	Data Range (multiplier)	Value Range / Enumerations	R/W
INPUTS						
Temperature Sensor	Displays current temperature measurement reading (built-in sensor) Note: Value depends on the temperature unit °C/°F selection	400	int16	-400..2480 (x10)	-40.0..120.0°C / -40.0..248.0°F	R
Humidity Sensor	Diplays current humidity measurement reading (With RH option)	401	int16	0..1000 (x10)	0..100%RH	R
CO2 Sensor	Displays current measurement CO2 reading (QER multisensors)	402	int16	0..10,000 (x1)	0..10,000ppm	R
VOC Sensor	Display current VOC (Volatile Organic Compound) Index Value	403	int16	0..500 (x1)	0..500 index	R
Universal Input 1	Universal Input 1 Measurement Note: Value depends on the temperature / mode selection	410	int16	-400..2480 (x10)	NTC Mode: -40..120° AI Mode: 0..100% = 0..10V	R
Universal Input 2	Universal Input 2 Measurement Note: Value depends on the temperature / mode selection	411	int16	-400..2480 (x10)	NTC Mode: -40..120° AI Mode: 0..100% = 0..10V	R
		DISCRETE INPUTS - FUNCTION CODE 02				
DI1	Digital Input 1 Status	200		0..1	0..1	R
DI2	Digital Input 2 Status	201		0..1	0..1	R
Occupancy Status	PIR (OE Option) Status	202		0..1	0..1	R
Push Button Status	Boost Button Status (TS Option) - Shows if Boost Button has been activated by the user.	204		0..1	0 = No Boost 1 = Boost	R
Screen Lock Status	Screen Lock Status	205		0..1	0 = Not Locked 1 = Locked	R
OUTPUTS						
		MODBUS INPUT REGISTERS - FUNCTION CODE 04 MODBUS HOLDING REGISTER - FUNCTION CODES 03, (06), 16				
Y1	Analogue Output 1 Value (Default Output Mode: Built-In Temperature)	412	uint16	0..1000 (x10)	0..100% = 0..10V	R/W
Y2	Analogue Output 2 Value (Default Output Mode: Humidity)	413	uint16	0..1000 (x10)	0..100% = 0..10V	R
Y3	Analogue Output 3 Value (Default Output Mode: CO2 Reading)	414	uint16	0..1000 (x10)	0..100% = 0..10V	R
Y4	Analogue Output 4 Value (Default Output Mode: VOC Index)	415	uint16	0..1000 (x10)	0..100% = 0..10V	R
		DISCRETE INPUTS - FUNCTION CODE 02				
Relay Status	Relay Output Status (RL Option)	203		0..1	0..1	R
DEMAND SIGNALS						
		MODBUS INPUT REGISTERS - FUNCTION CODE 04 MODBUS HOLDING REGISTER - FUNCTION CODES 03, (06), 16				
Fan Level	Current Fan Level / Fan Level Network Override (Range depends on the fan mode configuration). If TS model the fan level can be set from touchscreen or from network (last command prevails)	417	unit16	0..4	0..4 (Off / Speed1-2-3 / Auto)	R/W

Calculated Setpoint 1	Calculated Setpoint (Nominal Network Setpoint + User Adjustment, or the Absolute Setpoint)	418	uint16	-32000..32000 (x10)	-3200.0..3200.0	R
Calculated Setpoint 2	Calculated Setpoint (Nominal Network Setpoint + User Adjustment, or the Absolute Setpoint)	419	uint16	-32000..32000 (x10)	-3200.0..3200.0	R
Toggle Button State	Current State of the Toggle Button (TS-models only)	557	int16	0..1 (x1)	0..1	R
Lights Level	Lights Adjustment Level	680	uint16	0..1000 (x10)	0..100%	R
Blinds Level	Blinds Adjustment Level	681	uint16	0..1000 (x10)	0..100%	R

INPUT/OUTPUT SETTINGS						
Parameter	Description	Modbus Register / BACnet Property	MODBUS HOLDING REGISTER - FUNCTION CODES 03, 06, 16		Value Range / Enumerations	R/W
			Type	Data Range (multiplier)		
UNIVERSAL INPUTS						
UI1 Digital Polarity	UI1 Digital Input Polarity Setting - allows the polarity of the input operation to be reversed when used in digital modes.	514	uint16	0..1 (x1)	0 = Normal (Default) 1 = Reverse	R/W
UI2 Digital Polarity	UI2 Digital Input Polarity Setting - allows the polarity of the input operation to be reversed when used in digital modes..	515	uint16	0..1 (x1)	0 = Normal (Default) 1 = Reverse	R/W
UI1 Voltage Min.	Sets Min. Clamp Voltage for UI1.	516	uint16	0..100 (x10)	0..10.0 (Default 0)	R/W
UI1 Voltage Max.	Sets Max. Clamp Voltage for UI1. Use only if the connected device upper range is more than 3000.	517	uint16	0..100 (x10)	0..10.0 (Default 10.0)	R/W
UI2 Voltage Min.	Sets Min. Clamp Voltage for UI2. Advanced Setting.	518	uint16	0..100 (x10)	0..10.0 (Default 0)	R/W
UI2 Voltage Max.	Sets Max. Clamp Voltage for UI2. Use only if the connected device upper range is more than 3000.	519	uint16	0..100 (x10)	0..10.0 (Default 10.0)	R/W
UI1 Mode	Sets the Universal Input 1 Mode	520	uint16	0..4 (x1)	0 = Not Used 1 = 0..10V (0..100%) - Default 2 = NTC10 3 = Off / On 4 = Resistive - kOhms	R/W
UI2 Mode	Sets the Universal Input 2 Mode	521	uint16	0..4 (x1)		R/W
Temperature Units	Selects between Celcius and Fahrenheit Note: The display and network measurements will automatically reflect reading in the selected units.	522	uint16	0..1 (x1)	0 = Celcius (Default) 1 = Fahrenheit	R/W
UI1 Scale Min.	Sets the scaling for Min. Measurement when UI1 @ 0V (0%)	523	uint16	0..3000 (x10)	0.0..3000.0 (Default 0)	R/W
UI1 Scale Max.	Sets scaling for the Max. Measurement when UI1 @ 10V (100%)	524	uint16	0..3000 (x10)	0.0..3000.0 (Default 100.0)	R/W
UI2 Scale Min.	Sets the scaling for Min. Measurement when UI2 @ 0V (0%)	525	uint16	0..3000 (x10)	0.0..3000.0 (Default 0)	R/W
UI2 Scale Max.	Sets scaling for the Max. Measurement when UI2 @ 10V (100%)	526	uint16	0..3000 (x10)	0.0..3000.0 (Default 100.0)	R/W
Min Scaled Temperature	Scales the 0-10V output for temperature. Linear scaling, temperature value at 0V.	540	uint16	0..2120 (x10)	0..100° (32..212°F) Default 0°C	R/W
Max Scaled Temperature	Scales the 0-10V output for temperature. Linear scaling, temperature value at 10V.	527	uint16	0..2120 (x10)	0..100° (32..212°F) Default 50°C	R/W
Min Scaled Humidity	Scales the 0-10V output for humidity. Linear scaling, humidity value at 0V.	541	uint16	0..1000 (x10)	0..100%rh (Default 0%)	R/W
Max Scaled Humidity	Scales the 0-10V output for humidity. Linear scaling, humidity value at 10V.	528	uint16	0..1000 (x10)	0..100%rh (Default 100%)	R/W
Min Scaled CO2	Scales the 0-10V output for CO2. Linear scaling, CO2 value at 0V.	542	uint16	0..10000 (x1)	0..10,000ppm (Default 400)	R/W
Max Scaled CO2	Scales the 0-10V output for CO2. Linear scaling, CO2 value at 10V.	529	uint16	0..10000 (x1)	0..10,000ppm (Default 2000)	R/W
Max Scaled VOC	Scales the 0-10V output for VOC Linear scaling, VOC value at 10V. Note: VOC units are selected by the VOC measurement mode.	543	uint16	0..10000 (x1)	0..10,000 (Default 500)	R/W

ANALOGUE OUTPUTS						
Y1 Mode	Analogue Output Y1 Mode Default: Built-In Temperature Universal Input Mode: NTC - Output scaled 0..10V based on Max Scaled Temperature Analogue - 0..10V input scaled to 0..10V Digital Mode - Off = 0V, On = 10V Setpoint 1&2: Scales the setpoint value based on min/max settings to 0-10Vdc output signal.	530	uint16	0..13 (x1)	0 - Network 1 = Built-In Temperature 2 = Humidity 3 = CO2 Reading 4 = VOC Measurement 5 = Universal Input 1 6 = Universal Input 2 7 = Control Loop 1 8 = Control Loop 2	R/W
Y2 Mode	Analogue Output Y2 Mode Default: Humidity (when humidity sensor fitted)	531	uint16	0..11 (x1)	9 = Max Loop 1 and 2 10 = Setpoint 1 11 = Setpoint 2	R/W
Y3 Mode	Analogue Output Y3 Mode Default: CO2 Reading (when CO2 sensor fitted)	532	uint16	0..11 (x1)	12 = Lights Level 13 = Blinds Level	R/W
Y4 Mode	Analogue Output Y4 Mode Default: VOC Reading (when VOC sensor fitted)	533	uint16	0..11 (x1)		R/W
Y1 Override	Analogue Output Y1 Override Value	534	uint16	0..1000 (x10)	0.0..100.0% (Default 0)	R/W
Y2 Override	Analogue Output Y2 Override Value	535	uint16	0..1000 (x10)	0.0..100.0% (Default 0)	R/W
Y3 Override	Analogue Output Y3 Override Value	536	uint16	0..1000 (x10)	0.0..100.0% (Default 0)	R/W
Y4 Override	Analogue Output Y4 Override Value	537	uint16	0..1000 (x10)	0.0..100.0% (Default 0)	R/W
Network Value 1	Network Value 1 (for displaying network single decimal value). Set Display Location Source to 'Network Decimal Value' (1) Note: Only for Modbus variants. Use AV(13)/(14) for BACnet.	538	int16	-9990..9990 (x10)	-999.0..999.0 (Default 0)	R/W
Network Value 2	Network Value 2 (for displaying network integer value). Set Display Location Source to 'Network Integer Value' (2) Note: Only for Modbus variants. Use AV(13)/(14) for BACnet.	539	uint16	0..65535 (x1)	0..65535 (Default 0)	R/W

DIGITAL INPUTS AND OUTPUTS						
DI1 Off Delay	Delay Off Timer for the Universal Input 1 in Digital Input Mode	550	uint16	0..28,800 (x1)	0..28,800 seconds (default 0 secs)	R/W
DI2 Off Delay	Delay Off Timer for the Universal Input 2 in Digital Input Mode	551	uint16	0..28,800 (x1)	0..28,800 seconds (default 0 secs)	R/W
Relay Control Mode	Relay (RL Option) control mode. Relay can be configured to switch on measurements or based on the internal control logic.	552	uint16	0..11 (x1)	0 = Network 1 = Digital - PIR Status 2 = Digital UI1 3 = Digital UI2 4 = Control - Built-In Temp 5 = Control -UI1 6 = Control -UI2 7 = Control- Humidity 8 = Control - CO2 9 = Control - VOC Index 10 = Control - Loop 1 11 = Control - Loop 2	R/W
Relay High Setpoint	Relay High Setpoint. Measurement where the relay switches ON. Only applicable when Relay Control mode is set to Control (options 4-9). Note: If Low Setpoint is higher than the High Setpoint, the relay operation is reversed.	553	uint16	0..65000 (x10)	0..6500 (default 850.0)	R/W
Relay Low Setpoint	Relay Low Setpoint. Measurement where the relay switches OFF. Only applicable when Relay Control mode is set to Control.	554	uint16	0..65000 (x10)	0..6500 (default 750.0)	R/W
Relay Override	Overrides the current output status of the relay permanently (overrides the local control).	555	uint16	0..2 (x1)	0 = No override 1 = Override OFF 2 = Override ON	R/W
Movement Off Delay	Delay Off Timer for the PIR (movement) sensor	556	uint16	10..28,800 (x1)	10..28,800 seconds (default 600 secs)	R/W

Parameter	Description	Modbus Register	MODBUS HOLDING REGISTER - FUNCTION CODES 03, 06, 16		Value Range / Enumerations	R/W
			Type	Data Range (multiplier)		
COMMISSIONING OVERRIDES (Modbus Versions Only)						
Y1 Commission Override	Y1 Commissioning Override Parameter	690	uint16	0..3 (x1)	0 = Auto (Default) 1 = Manual Override 2 = 0% 3 = 100%	R/W
Y2 Commission Override	Y2 Commissioning Override Parameter	691	uint16	0..3 (x1)		R/W
Y3 Commission Override	Y3 Commissioning Override Parameter	692	uint16	0..3 (x1)		R/W
Y4 Commission Override	Y4 Commissioning Override Parameter	693	uint16	0..3 (x1)		R/W
Y1 Override	Analogue Output Y1 Override Value (used when 690 = Manual)	534	unit16	0..1000 (x10)	0.0..100.0% (Default 0)	R/W
Y2 Override	Analogue Output Y2 Override Value (used when 691 = Manual)	535	unit16	0..1000 (x10)	0.0..100.0% (Default 0)	R/W
Y3 Override	Analogue Output Y3 Override Value (used when 692 = Manual)	536	unit16	0..1000 (x10)	0.0..100.0% (Default 0)	R/W
Y4 Override	Analogue Output Y4 Override Value (used when 693 = Manual)	537	unit16	0..1000 (x10)	0.0..100.0% (Default 0)	R/W

CALIBRATION AND VOC MODE SETTINGS						
Parameter	Description	Modbus Register / BACnet Property	MODBUS HOLDING REGISTER - FUNCTION CODES 03, 06, 16		Value Range / Enumerations	R/W
			Type	Data Range (multiplier)		
Temperature Offset	Built-In Temperature Single Point Sensor Calibration Offset	580	int16	-100..100 (x10)	-10.0..+10.0deg (Default 0)	R/W
Humidity Offset	Humidity Single Point Calibration Offset	581	int16	-100..100 (x10)	-10.0..+10.0%rH (Default 0)	R/W
CO2 Offset	CO2 Single Point Calibration Offset (adjusts CO2 reading the specified amount)	582	int16	-500..500 (x1)	-500..+500ppm (Default 0)	R/W
CO2 Auto-Calibration	Shows if the auto-calibration of the CO2 has been Activated	583	uint16	0..1	0 = Disabled 1 = Enabled (Default)	R/W
CO2 Calibration Value	Single Point Calibration Value for the CO2 Sensor. Note: Writing this value will reset the calibration settings of the sensor to the value set. Only recommended for advanced users.	584	uint16	350..3,000 (x1)	350..3,000ppm	R/W
Force CO2 Calibration	Forces CO2 Calibration to the CO2 Calibration Value. Use when CO2 level known e.g with calibration gas or outside air.	585	uint16	0..1	0 = None 1 = Force Calibration	R/W
CO2 Calibration Persist	Store CO2 Calibration Settings in the Permanent Memory	586	uint16	0..1	0 = None 1 = Save Data	R/W
VOC Measurement Mode	VOC Measurement Mode Selection (Index, TVOC, Well Standard, Reaser Air Standard)	587	uint16	0..6	0 = VOC Index 1 = TVOC Ethanol, ppb (TVOC) 2 = TVOC Molhave, ug/m3 (Well) 3 = TVOC Isobutylene, ug/m3 (Reset) 4 = TVOC Ethanol, ug/m3 (TVOC) 5 = TVOC Molhave, ppb (Well) 6 = TVOC Isobutylene, ppb (Reset)	R/W
VOC Learning Time Offset	VOC Learning Time Offset. Set to 12 for Index mode and 720 for Building Standards Mode (from V1.62)	589	uint16	1..1,000 (x1)	1..1,000hours (Default 12)	R/W

DISPLAY SETTINGS						
Parameter	Description	Modbus Register / BACnet Property	MODBUS HOLDING REGISTER - FUNCTION CODES 03, 06, 16		Value Range / Enumerations	R/W
			Type	Data Range (multiplier)		
GENERAL						
Display Colour	Sets the display colour (display skin).	600	uint16	0..4	0 = White 1 = Green 2 = Blue 3 = Grey (default) 4 = Black	R/W
Display Brightness	Controls display brightness. By setting to Off, the display switches off after the timeout. Display wakes up when it is touched (TS models only)	601	uint16	0..6	0 = Off 1 = 5% 2 = 10% 3 = 25% 4 = 50% (default) 5 = 75% 6 = 100%	R/W
Temperature Display Resolution	Sets temperature display resolution (for built-in sensor only)	602	uint16	0..2 (x1)	0 = Fine (0.1°C/F) 1 = Normal (0.5°C/F) 2 = Coarse (1°C/F)	R/W
Occupancy Icon	Activates Occupancy Icon display (Man in the House) on the top status bar.	603	uint16	0..1	0 = Disabled (default) 1 = Enabled	R/W
Occupancy Icon Override	Occupancy Icon Network Override (Man In the House). Override the icon status between occupied and unoccupied. The display uses the last transition. Please note PIR (OE option) uses also the Occupancy Icon and it affects the icon status.	604	uint16	0..2	0 = No Override 1 = Override OFF 2 = Override ON	R/W
Enable Fan Display	Enables Fan Speed Display and/or Fan Speed Button for touchscreen models.	605	uint16	0..7	0 = Disabled (default) 1 = Display Only With -TS Option Only 2 = Touch-0-1 3 = Touch-0-1-2 4 = Touch-0-1-2-3 5 = Touch-0-1-A 6 = Touch-0-1-2-A 7 = Touch-0-1-2-3-A	R/W
Fan Level Override	Fan Level Network Override (overrides the fan speed). Range depends on the Fan Speed display configuration.	606	uint16	0..5	0 = Fan Override Off 1 = Fan Override Speed 1 2 = Fan Override Speed 2 3 = Fan Override Speed 3 4 = Fan Override Speed 4 5 = None (Default)	R/W
Toggle Button Override	Toggle Button Override (Locations 2 to 5). Overrides the toggle button location. (from fw 1.45)	558	uint16	0..2	0 = None 1 = Off 2 = On	R/W
DISPLAY LOCATION 1 (PRIMARY DISPLAY LOCATION)						
Location 1 Display	Location 1 Display Source. Sets what is displayed in Location 1.	610	uint16	0..10	0 = None 1 = Network Decimal Value 2 = Network Integer Value 3 = Temperature (Default) 4 = Universal Input 1 5 = Universal Input 2 6 = Humidity 7 = CO2 8 = VOC Index With Touchscreen 9 = Setpoint 1 10 = Setpoint 2	R/W

Location 1 Description	Location 1 Description. Sets description for Location 1.	611	uint16	0..27	0 = None 1 = Temperature 2 = Humidity 3 = CO2 (Default) 4 = VOC 5 = Light Level 6 = Pressure 7 = Room 8 = Outside 9 = Fan 10 = Energy 11 = Water 12 = Electricity 13 = Heating 14 = Cooling 15 = Zone 1 16 = Zone 2 17 = Temp. Set 18 = Hum. Set 19 = CO2 Set 20 = Aux. Set 21 = Room Set 22 = Zone 1 Set 23 = Zone 2 Set 24 = Window 25 = Blinds 26 = TVOC 27 = Flow	R/W
Location 1 Unit	Location 1 Unit. Sets unit for Location 1.	612	uint16	0..14	0 = None 1 = °C (Default) 2 = °F 3 = ppm 4 = Lux 5 = Pa 6 = kWh 7 = m3 8 = % 9 = index (air quality index) 10 = ppb 11 = ug/m3 12 = l/s 13 = m3/h 14 = cfm	R/W
Location 1 Alarm	Activates Location 1 Alarm Bar, Alarm Skin Colour or Descriptive Text indication. Using 1=Bar activates Green, Amber, Red alarm icon indication underneath the current displayed parameter. Using 3=Text activates LOW, MEDIUM HIGH text indication instead of the measurement. Using 3= Skin activates the skin colour changing based on alarm condition.	613	uint16	0..3	0 = Disabled 1 = Bar 2 = Text 3 = Skin	R/W
Location 1 Red Alarm Limit	Red Limit for Alarm 1 / High Limit for Descriptive Display	614	uint16	0..10,000 (x1)	0..10,000 (default 30)	R/W
Location 1 Amber Alarm Limit	Amber Limit for Alarm 1 / Medium Limit for Descriptive Displays	615	uint16	0..10,000 (x1)	0..10,000 (default 25)	R/W
Location 1 Hysteresis	Hysteresis for Alarm 1 / Low Limit for Descriptive Displays	616	uint16	0..10,000 (x1)	0..10,000 (default 1)	R/W
Location 1 Read Only	Sets the location 1 to be Read Only, Read/Write or Read-Write-NoLock. In Read Only mode touch functions are disabled for this location. In Read-Write-NoLock mode the touch actions are enabled even if the screen is locked.	645	uint16	0..2	0 = Read-Write (default) 1 = Read Only 2 = Read-Write-NoLock	R/W

DISPLAY LOCATION 2						
Location 2 Display	Location 2 Display Source. Sets what is displayed in Location 2. Note: 11 - Toggle Button option available from Fw 1.45	617	uint16	0..13	0 = None 1 = Network Decimal Value 2 = Network Integer Value 3 = Temperature 4 = Universal Input 1 5 = Universal Input 2 6 = Humidity 7 = CO2 (Default) 8 = VOC Index With Touchscreen 9 = Setpoint 1 10 = Setpoint 2 11 = Toggle Button 12 = Digital Input 1 State 13 = Digital Input 2 State	R/W
Location 2 Description	Location 2 Description	618	uint16	0..27	0 = None 1 = Temperature 2 = Humidity 3 = CO2 (Default) 4 = VOC 5 = Light Level 6 = Pressure 7 = Room 8 = Outside 9 = Fan 10 = Energy 11 = Water 12 = Electricity 13 = Heating 14 = Cooling 15 = Zone 1 16 = Zone 2 17 = Temp. Set 18 = Hum. Set 19 = CO2 Set 20 = Aux. Set 21 = Room Set 22 = Zone 1 Set 23 = Zone 2 Set 24 = Window 25 = Blinds 26 = TVOC 27 = Flow	R/W
Location 2 Unit	Location 2 Unit	619	uint16	0..14	0 = None 1 = °C 2 = °F 3 = ppm (Default) 4 = Lux 5 = Pa 6 = kWh 7 = m3 8 = % 9 = index (air quality index) 10 = ppb 11 = ug/m3 12 = l/s 13 = m3/h 14 = cfm	R/W
Location 2 Alarm	Activates Location 2 Alarm Bar, Alarm Skin Colour or Descriptive Text indication. Using 1=Bar activates Green, Amber, Red alarm icon indication underneath the current displayed parameter. Using 3=Text activates LOW, MEDIUM HIGH text indication instead of the measurement. Using 3= Skin activates the skin colour changing based on alarm condition.	620	uint16	0..3	0 = Disabled 1 = Bar 2 = Text 3 = Skin	R/W
Location 2 Red Alarm Limit	Red Limit for Alarm 2 / High Limit for Descriptive Display	621	uint16	0..10,000 (x1)	0..10,000 (default 1250)	R/W
Location 2 Amber Alarm Limit	Amber Limit for Alarm 2 / Medium Limit for Descriptive Displays	622	uint16	0..10,000 (x1)	0..10,000 (default 750)	R/W
Location 2 Hysteresis	Hysteresis for Alarm 2 / Low Limit for Descriptive Displays	623	uint16	0..10,000 (x1)	0..10,000 (default 100)	R/W

Location 2 Read Only	Sets the location 2 to be Read Only, Read/Write or Read-Write-NoLock. In Read Only mode touch functions are disabled for this location. In Read-Write-NoLock mode the touch actions are enabled even if the screen is locked.	646	uint16	0..2	0 = Read-Write (default) 1 = Read Only 2 = Read-Write-NoLock	R/W
----------------------	---	-----	--------	------	--	-----

DISPLAY LOCATION 3						
Location 3 Display	Location 3 Display Source. Sets what is displayed in Location 3.	624	uint16	0..13	0 = None 1 = Network Decimal Value 2 = Network Integer Value 3 = Temperature 4 = Universal Input 1 5 = Universal Input 2 6 = Humidity (Default) 7 = CO2 8 = VOC Index With Touchscreen 9 = Setpoint 1 10 = Setpoint 2 11 = Toggle Button 12 = Digital Input 1 State 13 = Digital Input 2 State	R/W
Location 3 Description	Location 3 Description	625	uint16	0..27	0 = None 1 = Temperature 2 = Humidity 3 = CO2 (Default) 4 = VOC 5 = Light Level 6 = Pressure 7 = Room 8 = Outside 9 = Fan 10 = Energy 11 = Water 12 = Electricity 13 = Heating 14 = Cooling 15 = Zone 1 16 = Zone 2 17 = Temp. Set 18 = Hum. Set 19 = CO2 Set 20 = Aux. Set 21 = Room Set 22 = Zone 1 Set 23 = Zone 2 Set 24 = Window 25 = Blinds 26 = TVOC 27 = Flow	R/W
Location 3 Unit	Location 3 Unit	626	uint16	0..14	0 = None 1 = °C 2 = °F 3 = ppm 4 = Lux 5 = Pa 6 = kWh 7 = m3 8 = % (Default) 9 = index (air quality index) 10 = ppb 11 = ug/m3 12 = l/s 13 = m3/h 14 = cfm	R/W
Location 3 Alarm	Activates Location 3 Alarm Bar, Alarm Skin Colour or Descriptive Text indication. Using 1=Bar activates Green, Amber, Red alarm icon indication underneath the current displayed parameter. Using 3=Text activates LOW, MEDIUM HIGH text indication instead of the measurement. Using 3=Skin activates the skin colour changing based on alarm condition.	627	uint16	0..3	0 = Disabled 1 = Bar 2 = Text 3 = Skin	R/W
Location 3 Red Alarm Limit	Red Limit for Alarm 3 / High Limit for Descriptive Display	628	uint16	0..10,000 (x1)	0..10,000 (default 80)	R/W

Location 3 Amber Alarm Limit	Amber Limit for Alarm 3 / Medium Limit for Descriptive Displays	629	uint16	0..10,000 (x1)	0..10,000 (default 60)	R/W
Location 3 Hysteresis	Hysteresis for Alarm 3 / Low Limit for Descriptive Displays	630	uint16	0..10,000 (x1)	0..10,000 (default 10)	R/W
Location 3 Read Only	Sets the location 3 to be Read Only, Read/Write or Read-Write-NoLock. In Read Only mode touch functions are disabled for this location. In Read-Write-NoLock mode the touch actions are enabled even if the screen is locked.	647	uint16	0..2	0 = Read-Write (default) 1 = Read Only 2 = Read-Write-NoLock	R/W
DISPLAY LOCATION 4						
Location 4 Display	Location 4 Display Source. Sets what is displayed in Location 4.	631	uint16	0..13	0 = None 1 = Network Decimal Value 2 = Network Integer Value 3 = Temperature 4 = Universal Input 1 5 = Universal Input 2 6 = Humidity 7 = CO2 8 = VOC Index (Default) With Touchscreen 9 = Setpoint 1 10 = Setpoint 2 11 = Toggle Button 12 = Digital Input 1 State 13 = Digital Input 2 State	R/W
Location 4 Description	Location 4 Description	632	uint16	0..27	0 = None 1 = Temperature 2 = Humidity 3 = CO2 (Default) 4 = VOC 5 = Light Level 6 = Pressure 7 = Room 8 = Outside 9 = Fan 10 = Energy 11 = Water 12 = Electricity 13 = Heating 14 = Cooling 15 = Zone 1 16 = Zone 2 17 = Temp. Set 18 = Hum. Set 19 = CO2 Set 20 = Aux. Set 21 = Room Set 22 = Zone 1 Set 23 = Zone 2 Set 24 = Window 25 = Blinds 26 = TVOC 27 = Flow	R/W
Location 4 Unit	Location 4 Unit	633	uint16	0..14	0 = None 1 = °C 2 = °F 3 = ppm 4 = Lux 5 = Pa 6 = kWh 7 = m3 8 = % 9 = index (default) 10 = ppb 11 = ug/m3 12 = l/s 13 = m3/h 14 = cfm	R/W

Location 4 Alarm	Activates Location 4 Alarm Bar, Alarm Skin Colour or Descriptive Text indication. Using 1=Bar activates Green, Amber, Red alarm icon indication underneath the current displayed parameter. Using 3=Text activates LOW, MEDIUM HIGH text indication instead of the measurement. Using 3= Skin activates the skin colour changing based on alarm condition.	634	uint16	0..3	0 = Disabled 1 = Bar 2 = Text 3 = Skin	R/W
Location 4 Red Alarm Limit	Red Limit for Alarm 4 / High Limit for Descriptive Display	635	uint16	0..10,000 (x1)	0..10,000 (default 140)	R/W
Location 4 Amber Alarm Limit	Amber Limit for Alarm 4 / Medium Limit for Descriptive Displays	636	uint16	0..10,000 (x1)	0..10,000 (default 120)	R/W
Location 4 Hysteresis	Hysteresis for Alarm 4 / Low Limit for Descriptive Displays	637	uint16	0..10,000 (x1)	0..10,000 (default 10)	R/W
Location 4 Read Only	Sets the location 4 to be Read Only, Read/Write or Read-Write-NoLock. In Read Only mode touch functions are disabled for this location. In Read-Write-NoLock mode the touch actions are enabled even if the screen is locked.	648	uint16	0..2	0 = Read-Write (default) 1 = Read Only 2 = Read-Write-NoLock	R/W

DISPLAY LOCATION 5						
		Modbus Register / BACnet Property	MODBUS HOLDING REGISTER - FUNCTION CODES 03, 06, 16			
Location 5 Display	Location 5 Display Source. Sets what is displayed in Location 5.	638	uint16	0..13	0 = None 1 = Network Decimal Value 2 = Network Integer Value 3 = Temperature 4 = Universal Input 1 5 = Universal Input 2 6 = Humidity 7 = CO2 8 = VOC Index (Default) With Touchscreen 9 = Setpoint 1 10 = Setpoint 2 11 = Toggle Button 12 = Digital Input 1 State 13 = Digital Input 2 State	R/W
Location 5 Description	Location 5 Description	639	uint16	0..27	0 = None 1 = Temperature 2 = Humidity 3 = CO2 (Default) 4 = VOC 5 = Light Level 6 = Pressure 7 = Room 8 = Outside 9 = Fan 10 = Energy 11 = Water 12 = Electricity 13 = Heating 14 = Cooling 15 = Zone 1 16 = Zone 2 17 = Temp. Set 18 = Hum. Set 19 = CO2 Set 20 = Aux. Set 21 = Room Set 22 = Zone 1 Set 23 = Zone 2 Set 24 = Window 25 = Blinds 26 = TVOC 27 = Flow	R/W

Location 5 Unit	Location 5 Unit	640	uint16	0..14	0 = None 1 = °C 2 = °F 3 = ppm 4 = Lux 5 = Pa 6 = kWh 7 = m3 8 = % 9 = index (default) 10 = ppb 11 = ug/m3 12 = l/s 13 = m3/h 14 = cfm	R/W
Location 5 Alarm	Activates Location 5 Alarm Bar, Alarm Skin Colour or Descriptive Text indication. Using 1=Bar activates Green, Amber, Red alarm icon indication underneath the current displayed parameter. Using 3=Text activates LOW, MEDIUM HIGH text indication instead of the measurement. Using 3= Skin activates the skin colour changing based on alarm condition.	641	uint16	0..3	0 = Disabled 1 = Bar 2 = Text 3 = Skin	R/W
Location 5 Red Alarm Limit	Red Limit for Alarm 5 / High Limit for Descriptive Display	642	uint16	0..10,000 (x1)	0..10,000 (default 140)	R/W
Location 5 Amber Alarm Limit	Amber Limit for Alarm 5 / Medium Limit for Descriptive Displays	643	uint16	0..10,000 (x1)	0..10,000 (default 120)	R/W
Location 5 Hysteresis	Hysteresis for Alarm 5 / Low Limit for Descriptive Displays	644	uint16	0..10,000 (x1)	0..10,000 (default 10)	R/W
Location 5 Read Only	Sets the location 5 to be Read Only, Read/Write or Read-Write-NoLock. In Read Only mode touch functions are disabled for this location. In Read-Write-NoLock mode the touch actions are enabled even if the screen is locked.	649	uint16	0..2	0 = Read-Write (default) 1 = Read Only 2 = Read-Write-NoLock	R/W

TOUCHSCREEN SETTINGS (TS MODELS ONLY)						
Parameter	Description	Modbus Register / BACnet Property	MODBUS HOLDING REGISTER - FUNCTION CODES 03, 06, 16		Value Range / Enumerations	R/W
			Type	Data Range (multiplier)		
GENERAL						
Enable Boost Button	Enables Boost Button on the bottom action bar	650	uint16	0..1	0 = Disabled (default) 1 = Enabled	R/W
Boost Time	Delay Off Timer for the Boost Button	651	uint16	0..28,800 (x1)	0..28,800 seconds 0 = Timer disabled, toggle functionality	R/W
Boost Target	Sets the boost operation target	652	uint16	0..2	0 = None 1 = Control Loop 1 Output 2 = Control Loop 2 Output	R/W
Lock Code	Screen Lock Code - 0000 = User requires no code to lock the screen	653	uint16	0..9,999 (x1)	0..9,999 (Default 0000)	R/W
Auto Lock	Enables Auto Lock of the Screen (approx 3 minutes after unlocking the screen)	656	uint16	0..1	0 = Disabled (default) 1 = Enabled	R/W
Screen Lock Override	Overrides the Current State of the Screen Lock	654	uint16	0..2 (x1)	0 = No Override 1 = Unlock Screen 2 = Lock Screen	R/W
Config Code	Code to Enter Configuration Screen, Set to 0000 to bypass the requirement to enter the code.	655	uint16	0..9,999 (x1)	0..9,999 (Default 8000)	R/W
Setpoint Slider Screen	When enabled shows the Setpoint Slider Screen when adjusting setpoint. Disabled shows setpoint on the main screen.	608	uint16	0..1 (x1)	0 = Disabled 1 = Enabled (Default)	R/W

DATA LOGGING						
History 1 Display	Default Display for Historical Logging Location 1. Activates the history access button on the bottom action bar.	660	uint16	0..6	0 = Disabled 1 = Built-In Temp	R/W
History 2 Display	Default Display for Historical Logging Location 2. Activates the history access button on the bottom action bar. Note: History is stored in the RAM memory only and is lost during the power interrupt.	661	uint16	0..6	2 = Universal Input 1 3 = Universal Input 2 4 = Humidity 5 = CO2 6 = VOC Index 7 = PIR (Movement) 8 = DI1 (UI1) 9 = DI2 (UI2)	R/W
Logging Interval	History Logging Interval	662	uint16	0..5	0 = 10 seconds 1 = 30 seconds 2 = 1 minute 3 = 3 minutes 4 = 30 minutes 5 = 90 minutes	R/W
SETPOINT (NETWORK DISPLAY) - DATA TYPE ADJUSTABLE TO INTEGER (x1) OR DECIMAL(x10)						
Nominal Setpoint 1	Nominal Setpoint 1. The calculated setpoint is displayed at Register 418 Note: If setpoint changed from network, the user adjustment is reset to zero	670	uint16	-27000..27000 (x1/x10) Note: Scaling set by 'Setpoint 1 Data Type'	x1: -27000..+27000 x10: -2700.0..2700.0 - Default 21.0 (x10)	R/W
Setpoint 1 Min Adj Limit	Minimum Setpoint Adjustment Limit for Setpoint 1	671	int16	-27000..27000 (x1/x10)	x1: -5000..0 x10: -500.0..0 (default -3.0)	R/W
Setpoint 1 Max Adj Limit	Maximum Setpoint Adjustment Limit for Setpoint 1	672	int16	-27000..27000 (x1/x10)	x1: 0..5000 x10: 0..500.0 (default +3.0)	R/W
Setpoint 1 Resolution	Setpoint 1 Adjustment Resolution	673	uint16	1..100 (x1/x10)	x1: 1..100 x10: 0.1..10.0 (default 0.1)	R/W
Setpoint 1 Data Type	Setpoint 1 Data Type. Data Type parameter defines if the parameters 670-673 are scaled with x1 or with x10 (multiplier 10).	674	uint16	0..1	0 = Integer (x1) 1 = Decimal (x10) - Default	R/W
Setpoint 1 Adjustment	Sets the Setpoint 1 user adjustment limits to use relative or absolute min/max settings.	668	uint16	0..1	0 = Relative - Default 1 = Absolute	R/W
Nominal Setpoint 2	Nominal Setpoint 2 The calculated setpoint is displayed at Register 419 Note: If setpoint changed from network, the user adjustment is reset to zero	675	uint16	-27000..27000 (x1/x10) Note: Scaling set by 'Setpoint 2 Data Type'	x1: -27000..+27000 - Default 750 (x1) x10: -2700.0..2700.0	R/W
Setpoint 2 Min Adj Limit	Minimum Setpoint Adjustment Limit for Setpoint 2	676	int16	-27000..27000 (x1/x10)	x1: -5000..0 (default -250) x10: -500.0..0	R/W
Setpoint 2 Max Adj Limit	Maximum Setpoint Adjustment Limit for Setpoint 2	677	int16	-27000..27000 (x1/x10)	x1: 0..5000 (default 250) x10: 0..500.0	R/W
Setpoint 2 Resolution	Setpoint 2 Adjustment Resolution	678	uint16	1..100 (x1/x10)	x1: 1..100 (default 50) x10: 0.1..10.0	R/W
Setpoint 2 Data Type	Setpoint 2 Data Type. Data Type parameter defines if the parameters 675-678 are scaled with x1 or with x10 (multiplier 10).	679	uint16	0..1	0 = Integer (x1) (Default) 1 = Decimal (x10)	R/W
Setpoint 2 Adjustment	Sets the Setpoint 2 user adjustment limits to use relative or absolute min/max settings.	669	uint16	0..1	0 = Relative - Default 1 = Absolute	R/W
LIGHTS AND BLINDS						
Lights Level	Lights Level Adjustment	680	uint16	0..1000 (x10)	0..100%	R/W
Blinds Level	Blinds Level Adjustment	681	uint16	0..1000 (x10)	0..100%	R/W
Lights Increment	Lights Level Adjustment Increment Default: 8 - 10 Levels (0/10/20/30/40/50/60/70/80/90/100%)	682	uint16	0..9 (x1)	0 = Off / On (0 - 100%) 1 = 2 Steps (50% inc) 2 = 3 Steps (33.4% inc) 3 = 4 Steps (25% inc)	R/W
Blinds Increment	Blinds Level Adjustment Increment Default: 8 - 10 Steps (0/10/20/30/40/50/60/70/80/90/100%)	683	uint16	0..9 (x1)	4 = 5 Steps (20% inc) 5 = 6 Steps (16.7% inc) 6 = 7 Steps (14.3% inc) 7 = 8 Steps (12.5% inc) 8 = 10 Steps (10% inc) 9 = 20 Steps (5% inc)	R/W

CONTROL SETTINGS						
Parameter	Description	Modbus Register / BACnet Property	MODBUS HOLDING REGISTER - FUNCTION CODES 03, 06, 16		Value Range / Enumerations	R/W
			Type	Data Range (multiplier)		
Control Loop 1 Source	Control Loop Source Note: Setting to 'None' allows the control loop output be controlled only by Boost button (TS models)	700	uint16	0..5 (x1)	0 = None 1 = Temperature (default) 2 = Humidity 3 = CO2 4 = VOC	R/W
Control Loop 1 Setpoint	Control Loop Setpoint	701	uint16	0..1 (x1)	0 = Setpoint 1 (default) 1 = Setpoint 2	R/W
Control Loop 1 PB	Control Loop Proportional Band	702	uint16	1..5000 (x1)	1..5000 (Default 5)	R/W
Control 1 IA	Control Loop 1 Integral Action Time	703	uint16	0..3600 (x1)	0..3600 sec (default 0s) 0 = Disabled	R/W
Control 1 Direction	Control Loop 1 Direction; For Temperature Reverse = Heating, Direct = Cooling	704	uint16	0..1 (x1)	0 = Reverse 1 = Direct (Default)	R/W
Control 2 Loop Source	Control Loop 2 Source Note: Setting to 'None' allows the control loop output be controlled only by Boost button (TS models)	705	uint16	0..5 (x1)	0 = None 1 = Temperature 2 = Humidity 3 = CO2 (Default) 4 = VOC	R/W
Control 2 Loop Setpoint	Control Loop 2 Setpoint	706	uint16	0..1 (x1)	0 = Setpoint 1 1 = Setpoint 2 (Default)	R/W
Control Loop 2 PB	Control Loop 2 Proportional Band	707	uint16	1..5000 (x1)	1..5000 (Default 500)	R/W
Control 2 IA	Control Loop 2 Integral Action Time	708	uint16	0..3600 (x1)	0..3600 sec (default 0s) 0 = Disabled	R/W
Control 2 Direction	Control Loop 2 Direction; For CO2 Control Set Direct	709	uint16	0..1 (x1)	0 = Reverse 1 = Direct (Default)	R/W

SYSTEM AND COMMUNICATION SETTINGS						
Parameter	Description	Modbus Register / BACnet Property	MODBUS HOLDING REGISTER - FUNCTION CODES 03, 06, 16		Value Range / Enumerations	R/W
			Type	Data Range (multiplier)		
Address	Modbus Address BACnet MAC Address	800	uint16	1..247 (x1) 1..127 (x1)	Modbus: 1..247 BACnet: 1..127	R/W
Baud Rate	Baud Rate	801	uint16	0..5	0 = 9600 1 = 19200 2 = 38400 3 = 57600 4 = 76800 5 = 115200	R/W
Modbus Parity	Modbus Parity	802	uint16	0..2	0 = None 1 = Odd 2 = Even	R/W
Modbus Stopbits	Modbus Stopbits	803	uint16	0..1	0 = 1 Stop Bit 1 = 2 Stop Bits	R/W
Soft Reset	Soft Reset	810	uint16	0..1	0 = Normal 1 = Reset	R/W
Persist	Persist (Store Parameters in Non-Volatile Memory after changes) NOTE: DO NOT WRITE FREQUENTLY TO THIS REGISTER. IT IS ONLY APPLIED AFTER CONFIGURATION CHANGES.	811	uint16	0..1	0 = Normal 1 = Persist	R/W
Reload Defaults	Reload Defaults (NOTE: Resets all settings to factory defaults)	812	uint16	0..1	0 = Normal 1 = Factory Defaults	R/W
Service Pin	Service Pin (BACnet Only)	813	uint16	0..1	0 = Normal 1 = Service Pin	R/W
Language Pack Enable	Enables the Language Pack (using language pack it is possible to change the user text entries on the screen)	814	uint16	0..1	0 = English 1 = Language Pack Enabled	R/W

Logo Timer	Time after which the Logo is displayed on the Display after background level is activated. Set to 0 to disable the logo.	815	uint16	0..255 (x1)	1..255 seconds 0 = Logo Disabled	R/W
Firmware Version	Firmware Version	820	uint16	N/A	N/A	R
Serial Number	Serial Number	821	uint16	N/A	N/A	R
Date Code	Date Code	822	uint16	N/A	N/A	R
Product ID	Product ID	823	uint16	N/A	N/A	R
Device ID	BACnet Device ID. Set to 0 to use Automatically generated ID. Follow change with "Persist" and "Reset".	825	uint32	0..4,194,303 (x1)	0..4,194,303	R/W

LORA AUTOMATIC PAYLOAD CONFIGURATION						
Parameter	Description	Modbus Register / BACnet Property	MODBUS HOLDING REGISTER - FUNCTION CODES 03, 06, 16		Value Range / Enumerations	R/W
			Type	Data Range (multiplier)		
Uplink Register 1	LoraWan Automatic Uplink Payload Register 1. Configure to be the register number to be read in the message. (Default: Temp)	850	uint16	1..1000 (x1)	400..1000 (Default 400)	R/W
Uplink Reg 2	LoraWan Automatic Uplink Payload Register 2 (Def: Humidity)	851	uint16	1..1000 (x1)	400..1000 (Default 401)	R/W
Uplink Reg 3	LoraWan Automatic Uplink Payload Register 3 (Def: CO2)	852	uint16	1..1000 (x1)	400..1000 (Default 402)	R/W
Uplink Reg 4	LoraWan Automatic Uplink Payload Register 4 (Def: VOC)	853	uint16	1..1000 (x1)	400..1000 (Default 403)	R/W
Uplink Reg 5	LoraWan Automatic Uplink Payload Register 5 (Def: UI1)	854	uint16	1..1000 (x1)	400..1000 (Default 410)	R/W
Uplink Reg 6	LoraWan Automatic Uplink Payload Register 6 (Def: UI2)	855	uint16	1..1000 (x1)	400..1000 (Default 411)	R/W
Uplink Reg 7	LoraWan Automatic Uplink Payload Register 7 (Def: Y1)	856	uint16	1..1000 (x1)	400..1000 (Default 412)	R/W
Uplink Reg 8	LoraWan Automatic Uplink Payload Register 8 (Def: Y2)	857	uint16	1..1000 (x1)	400..1000 (Default 413)	R/W
Uplink Reg 9	LoraWan Automatic Uplink Payload Register 9 (Def: Y3)	858	uint16	1..1000 (x1)	400..1000 (Default 414)	R/W
Uplink Reg 10	LoraWan Automatic Uplink Payload Register 10 (Def: Y4)	859	uint16	1..1000 (x1)	400..1000 (Default 415)	R/W
Uplink Reg 11	LoraWan Automatic Uplink Payload Register 11 (Def: Calc SP1)	860	uint16	1..1000 (x1)	400..1000 (Default 418)	R/W
Uplink Reg 12	LoraWan Automatic Uplink Payload Register 12 (Def: Calc SP2)	861	uint16	1..1000 (x1)	400..1000 (Default 419)	R/W
Write Register 1	LoraWan Packaged Write Payload Register 1. Configure to be the register number to be written. (Default: Setpoint1)	862	uint16	1..1000 (x1)	400..1000 (Default 670)	R/W
Write Register 2	LoraWan Packaged Write Payload Register 2. (Def: Setpoint2)	863	uint16	1..1000 (x1)	400..1000 (Default 675)	R/W
Write Register 3	LoraWan Packaged Write Payload Register 3. (Def: None)	864	uint16	1..1000 (x1)	400..1000 (Default 0)	R/W
Write Register 4	LoraWan Packaged Write Payload Register 4. (Def: None)	865	uint16	1..1000 (x1)	400..1000 (Default 0)	R/W
Write Register 5	LoraWan Packaged Write Payload Register 5. (Def: None)	866	uint16	1..1000 (x1)	400..1000 (Default 0)	R/W
Write Register 6	LoraWan Packaged Write Payload Register 6. (Def: None)	867	uint16	1..1000 (x1)	400..1000 (Default 0)	R/W
Transmission Interval	Lora Uplink Message Transmission Interval, minutes	847	uint16	1..9 (x1)	0 = 1min 1 = 2min 2 = 3min 3 = 4min 4 = 5min 5 = 6min 6 = 10min (default) 7 = 15min 8 = 30min 9 = 60min	R/W
Lora Version	Reports the Lora Firmware Version	875	uint16	1..9999 (x1)	n/a (V2.03 latest as Apr25)	R

The following registers are available with Modbus only. The registers combine two parameters to a single 16-bit (2 Bytes) Modbus register.

MODBUS SPECIFIC COMBINATION REGISTERS						
Parameter	Description	MODBUS INPUT REGISTERS - FUNCTION CODE 04 MODBUS HOLDING REGISTER - FUNCTION CODES 03, 16				
			Type	Data Range (multiplier)	Value Range / Enumerations	R/W
Y1/Y2	Combined 16-Bit Register for Outputs Y1 and Y2. E.g. Y1=0x64 (100%), Y2=0x64 (100%) Register=0x6464 (25700)	450	unit16	0..25700 (x1) 0x0000..0x6464	Byte 1:Y1 (0x00..0x64), Byte 2:Y2 (0x00..0x64)	R
Y3/Y4	Combined 16-Bit Register for Outputs Y3 and Y4	451	unit16	0..25700 (x1) 0x0000..0x6464	Byte 1: Y3 (0x00..0x64), Byte 2: Y4 (0x00..0x64)	R
Device Status	Combined 16-Bit Register for Binary Status of the Device	455	unit16	0..25700 (x1)	Bit0 - DI1, Bit1 = DI2, Bit3 = PIR, Bit4 = Relay, Bit5= Boost, Bit6 = Screen Lock	R

Bacnet Protocol Implementation Statement (PICS) and BACnet Objects

The -BAC versions of the sensors come with BACnet MS/TP communication. The following tables describe the PICS (Protocol Implementation Conformance Statement) and BACnet Objects (Standard and Proprietary). The Proprietary Objects are used for the device configuration.

GENERAL INFORMATION	
Date:	Sep 1, 2022
Vendor Name:	Senticon Ltd
Vendor ID:	1374
Product Name:	xER Smart Room Sensors
Product Models:	TERxx, MERxx. QERxx, VERxx
Applications Software Version:	1.0
Firmware Revision:	1.0.0
BACnet Prorocol Revision	1.19
Product Description:	Smart Room Sensors
BACnet Standard Device Profile:	BACnet Application Specific Controller (B-ASC)
BACnet Interoperability Blocks Supported:	Data Sharing - ReadProperty-B (DS-RP-B) Data Sharing - ReadPropertyMultiple-B (DS-RPM-B) Data Sharing - WriteProperty-B (DS-WP-B) Data Sharing - COV-B (DS-COVU-B) Device Management - DynamicDeviceBinding-B (DM-DDB-B) Device Management - DynamicObjectBinding-B (DM-DOB-B) Device Management - DeviceCommunicationControl-B (DM-DCC-B)
Segmentation Capability:	No
Data Link Layer Options:	MS/TP Master; Supported Baud 9600/19200/38400/57600/76800/115200
Device Address Binding:	No static device binding supported
Networking Options:	None
Character Sets Supported:	ISO 10646 (UTF-8)
Gateway Options:	None
Network Security Options:	Non-Secure Device

Standard Object Types Supported:	Object Type:	Optional Properties	Writeable Properties
	Analog Value:	Description, COV Increment, Relinquish Default	Present Value COV Increment
	Binary Value:	Description, Inactive_Text, Active_Text	Present Value
	Device Object:	Description Active COV Subscriptions Max Master	Object Identifier Object Name APDU Timeout (0...60000) Number Of APDU Retries (0...10) Max Master (1...127)
<p><i>For all supported objects, device does not support CreateObject or DeleteObject.</i></p> <p><i>For Analog Value objects that are classified as read only, there is the following behavior:</i></p> <ul style="list-style-type: none"> - HVAC application overwrites the present value that has been written with the Write Property Service. - In this case, no error message will be sent. <p><i>The device application checks the ranges of the Present Value and the COV Increment of the Analog Objects. For this reason, there is the following behavior:</i></p> <ul style="list-style-type: none"> - No error message, if the limits have been exceeded - Too high values are set to the range maximum - Too small values are set to the range minimum 			

OBJECT TYPE: DEVICE OBJECT				
Object Instance	Property Identifier	Value Range	Default Value	R/W
Device[x]	Object Identifier		MAC_Address	R/W
	Object Name	32 chars max.		R/W
	Object_Type		8	R
	System_Status		Status_Operational	R
	Vendor_Name		Senticon Ltd	R
	Vendor_Identifier		1374	R
	Model_Name		xER	R
	Firmware_Revision		1.0.0	R
	Application_Software_Version		1.0	R
	Protocol_Version		1	R
	Protocol_Revision		19	R
	Protocol_Services_Supported		See General Information	R
	Protocol_Object_Types_Supporte		See General Information	R
	Object_List		See Objects List	R
	Max_APDU_Length_Accepted		480	R
	Segmentation_Supported		No	R
	APDU_Timeout		6000 ms	R/W
	Number_Of_APDU_Retries		3	R/W
	Max_Master		127	R/W
	Device_Address_Binding			R
Database_Revision		0	R	
Property_List			R	

OBJECT TYPE: ANALOGUE VALUE						
Object Instance	Object Name	Value Range	Relinquish_Default	Units	COV Increment	R/W
AV(0)	Temperature	-40.0..120.0°C / -40.0..248.0°F	-	DEGREES_CELCIUS or DEGREES_FAHRENHEIT	0.0..100 (Default 1)	R
AV(1)	Humidity	0...100.0	-	RELATIVE_HUMIDITY	0.0..100 (Default 5)	R
AV(2)	CO2	0...10,000	-	PARTS_PER_MILLION	0.0..100 (Default 50)	R
AV(3)	VOC	0..1,000	-	NO_UNITS	0.0..100 (Default 10)	R
AV(4)	UI1	-40.0..120.0°C / -40..248°F 0..100.0%	-	DEGREES_CELCIUS or DEGREES_FAHRENHEIT or PERCENT	0.0..100 Default 1	R

AV(5)	UI2	-40.0..120°C / -40..248°F 0..100.0%	-	DEGREES_CELCIUS or DEGREES_FAHRENHEIT or PERCENT	0.0..100 Default 1	R
AV(6)	Y1	0.0..100.0%	-	PERCENT	5	R/W
AV(7)	Y2	0.0..100.0%	-	PERCENT	5	R/W
AV(8)	Y3	0.0..100.0%	-	PERCENT	5	R/W
AV(9)	Y4	0.0..100.0%	-	PERCENT	5	R/W
AV(10)	Setpoint_1	-2700.0..2700.0	Nonvol_Setpoint	DEGREES_CELCIUS or DEGREES_FAHRENHEIT or PARTS_PER_MILLION or PERCENT	5	R/W
AV(11)	Setpoint_2	-2700.0..2700.0	Nonvol_Setpoint	DEGREES_CELCIUS or DEGREES_FAHRENHEIT or PARTS_PER_MILLION or PERCENT	5	R/W
AV(12)	Fan_Speed	0..4.0	Nonvol_FanSpeed	NO_UNITS	1	R/W
AV(13)	Network_Decimal	-999.0..999.0	Nonvol_Setpoint	NO_UNITS	0	R/W
AV(14)	Network_Integer	0..65535.0	Nonvol_Setpoint	NO_UNITS	0	R/W
AV(15)	Lights Level	0.0..100.0%	-	PERCENT	5	R/W
AV(16)	Blinds Level	0.0..100.0%	-	PERCENT	5	R/W

NOTE: Priority Input 16 is reserved for internal value. If COV increment is set to 0.0 (default), the COV is disabled.

NOTE: AV(10), AV(11) and AV(12) Priority Inputs 1 to 15 have to be set to 'Null' in order for the user to be able to change the settings from the display (Setpoint_1, Setpoint_2 and Fan_Speed).

OBJECT TYPE: BINARY VALUE					
Object Instance	Object Name	Description	Present Value Range / Active - Inactive Tex	Relinquish_Default	R/W
BV(0)	DI_1	Digital Input 1 Status	0: InActive 1: Active	Binary_Inactive	R
BV(1)	DI_2	Digital Input 2 Status	0: InActive 1: Active	Binary_Inactive	R
BV(2)	Occupancy	PIR Sensor Status	0: InActive 1: Active	Binary_Inactive	R
BV(3)	DO_1	Digital Output (Relay) Status	0: InActive 1: Active	Binary_Inactive	R/W
BV(4)	Boost	Boost Button Status (Active / non-active)	0: InActive 1: Active	Binary_Inactive	R/W
BV(5)	Screen_Lock	Locks / Unlocks Screen	0: InActive (Unlocked) 1: Active (Locked)	Binary_Inactive	R/W
BV(6)	Toggle_Button	Toggle Button Status	0: InActive (Unlocked) 1: Active (Locked)	Binary_Inactive	R/W

NOTE:Note: Priority Input 16 is reserved for Internal Value.

NOTE: BV(5) - Set Priority Inputs 1-15 to 'null' to allow the user to unlock/lock the device

PROPRIETARY OBJECT
OBJECT NAME / TYPE: "CONFIGx" / 128
The devices have five instances of proprietary Device Configuration objects split as with the configuration tools; Cfg_IO, Cfg_Calibration, Cfg_Display, Cfg_Touchscreen, Cfg_System. The devices can be fully configured using the properties of these configuration objects. Full list of available properties are listed in the <i>Device Setup and Modbus/BACnet Communication</i> section tables.

In addition to the generic parameters, the BACnet AV (AV0 to AV12) and BV (BV0 to BV4) objects have proprietary property to enable COV (Unsubscribed COV) function. For the AV0 to AV5 objects the modified COV increment is stored in the non-volatile memory. For the BV objects data is transmitted when the state changes.

NOTE: Enabling COV increases network load as the messages are broadcasted to all devices. For efficient network performance limit the number of COV objects to minimal and configure routers to allow broadcasts only on the subnets.

BACNET COV OBJECT SETTINGS						
Parameter	Description	BACnet Property	Type	Data Range (multiplier)	Value Range / Enumerations	R/W
AVx COV	AV Object COV Enable Flag x = AV Object Number	100x	uint16	0..1(x1)	0 = COV Disabled 1 = COV Enabled	R/W
BVx COV	BV Object COV Enable Flag x = BV Object Number	110x	uint16	0..1(x1)	0 = COV Disabled 1 = COV Enabled	R/W

Dimensions and Installation

The devices typically mounted on the flat wall surfaces or on the junction boxes. The enclosure has 56/60mm screw distance for standard mounting boxes.

Installation Notes:

- Follow the diagram below to open the enclosure to access the mounting holes and the wiring terminals.
- Install the sensors away from the sources of heat and cool e.g. from direct sunlight or cold external walls.
- Install the sensors at 120-150 cm height for optimal performance.
- For correct movement (PIR) sensor operation consider the location of the sensor carefully.
- Make sure that the cable entries and junction boxes are sealed from air flows. This is the most common reason for inaccuracies in temperature measurement.
- Bring the cables through the dedicated hole (black area) marked on the dimensions drawing.
- If surface mounted cable is required to be used, the top of the enclosure (center) has a thin wall section that can be cut.

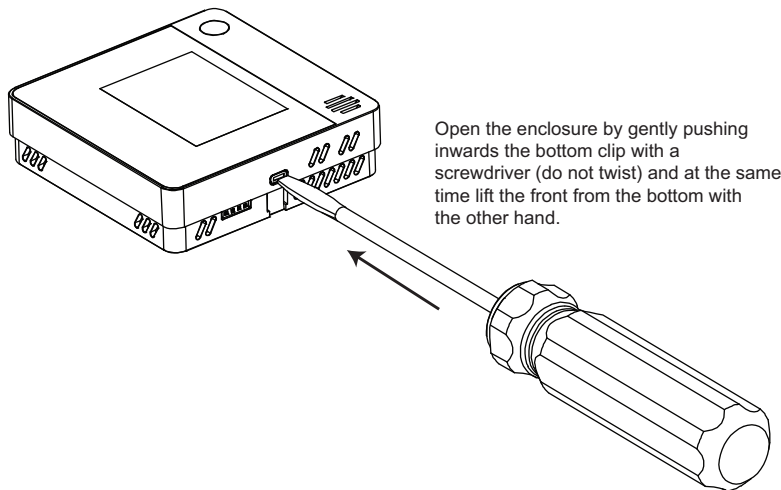

DIMENSIONS (xER10 SERIES)

