

PS2.04 TCR81/82/83 Series Ceiling Mounted Room Controllers



TCR80 SERIES CONTROLLER



UP TO 2 x TDR20/QDR20
ROOM INTERFACE
PANELS

The TCR80 Series Controllers are ceiling mounted room controllers for controlling up to two rooms. The controllers have IP65 rated enclosure with cable glands, and are available with 24V or 230V power supply. The controllers can be connected to up to two room display panels using the USB-C cables, making installation and connection simple. The controller built-in universal inputs can be used with cable sensors. The room interface panels have temperature measurement, setpoint, fan speed, boost function and operating mode selection (configurable). In addition the room interface panels can have optional humidity, VOC, CO2 and occupancy measurements.

The controllers have built-in Modbus RTU or BACnet MS/TP communication that allow interaction to the BMS systems. The controllers can be configured using Windows Configuration Tool over the USB-SERIAL or wireless Bluetooth BLE-TOOLSET. The controllers can also be configured over the Modbus/BACnet, or using iOS Mobile Phone/iPad application.

Features

- Advanced Room Controllers for wide variety of room control applications.
- Controls up to 2 rooms - connection up to 2 Room Display Interfaces (via communication bus using USB-C cable)
- BACnet MS/TP and Modbus RS485 RTU with up to 60V industrial isolation on RS485 for system integration
- 24V and 230V Power Supply versions
- TCR81/TCR83: 2 x Universal Inputs (temperature/0-10V/digital)
- TCR82: 4 x Universal Inputs (temperature/0-10V/digital) offer application flexibility
- 4 x Analogue 0..10Vdc Outputs, max 2mA
- TCR81/83: 2 x 24Vac Triacs, TCR82: 4 x 24Vac Triacs (require 24Vac or 230V supply), TCR83: 3 x 230V
- Sensor Bus for Connecting up to two Room Interface Panels (TCR81: 1x, TCR82: 2x)
- Configuration wirelessly through Smart Configuration Windows Software or Smart Phone iOS App (using Bluetooth Dongles). SmartView SmartPhone App for device interrogation for end users.
- IP65 Wall/Ceiling Mounted Enclosure with 4 x M16 6-12mm Conduit Entries, 4 x M16 4-8mm Conduit Entries
- Designed for Installers in mind with Spring Loaded pluggable spring-loaded terminal blocks and Sufficient Wiring Space

Technical Specifications

Power Supply:	Power:	24V Models: 24Vac/dc -10%/+15%, max 180mA with two Room Interface Panels 230V Models: 230Vac
Inputs:	Universal Inputs:	TCR81: 2 x Universal Inputs - RI/AI/DI Application Selected TCR82: 4 x Universal Inputs - RI/AI/DI Application Selected RI = NTC10 Measurement RI = Resistive kOhms Measurement, 0.1..500kOhms, Accuracy: 0.1+/-2% kOhms of the reading (1..80kOhms), resolution 0.1 kOhms AI = 0..10Vdc Input, display resolution 0.1 Volts DI = Digital Volt-Free Input
Outputs:	Analogue Outputs:	4 x 0..10Vdc, min. load resistance >5 kOhms (max. 2mA @ 10V)
	Digital Outputs:	TCR81: 2 x 24Vac Rated Triacs, Switching to 0V, Max 1A load TCR82: 4 x 24Vac Rated Triacs, Switching to 0V, Max 1A load (for thermic wax actuators or 3-point raise/lower actuators) Note: Requires 24VAC or 230V Power Supply Note: 230Vac variants can provide up to 8VA for the thermic actuators.
Communication:	Relay Outputs:	TCR83: 3 x 250VAC Relays, max switching power 90W (Fan Motor Control)
	Physical Interface	1 x RS485 driver with up to 60V industrial Isolation, recommended max 63 devices
	Protocol:	Modbus RTU or BACnet MS/TP (order relevant model)
	Addressing:	Via Bitswitch: 1..127 Via Software: 1..247 for Modbus, 1..127 for BACnet MS/TP
	Settings:	Baud Rate: 9600/19200/38400/76800 (bitswitch), 57600/115200 (software) Modbus Parity: None/Even/Odd, Modbus Stop Bits: 1 or 2
Wireless Communication:	Bluetooth (Option):	Bluetooth Interface to SmartPhone App or BLE USB Dongle (Device Config Tool)
	LoraWan (Option):	LoraWan® Wireless Interface (EU868, US915, AS923) Encrypted LoraWan® 1.0.3 Class C Device with secure OTAA activation with IPEX antenna for long-range communication. Configurable Uplink and Downlink Messages.
Sensor Bus:	Physical Interface	TCR81: 1 x USB-C Connector for the Room Interface Panels (TDR/QDR20) TCR82: 2 x USB-C Connector for the Room Interface Panels (TDR/QDR20) Each connector provides RS485, 0V and 5Vdc Option: 5V, 0V, TX, RX Spring Loaded Terminals Block
Mechanical:	Wiring Terminals:	Spring Loaded Push Fit Terminals, 0.2 to 2.5mm ² / 26 to 12 AWG 4 x M16 and 4 x M20 Cable Glands
	Enclosure:	ABS Plastics - White, IP65 Rating
	Mounting:	Wall or Ceiling Mounting
	Dimensions	W220 x H140 x D75mm

Model Selection

Refer to the below table to select the required model.

Part Number		SKU# Number					
Example	TCR82-MOD-24-W	8200	1	00	60	10	0 2
Product Name		Product	Product Options				
TCR81	Ceiling Mounted Room Controller, 2UI, 4AO, 2DO, 1 x Room Interface Units	8100					
TCR82	Ceiling Mounted Room Controller, 4UI, 4AO, 4DO, 2 x Room Interface Units	8200					
TCR83	Ceiling Mounted Room Controller, 2UI, 2AO, 2DO, 3RO, 1 x Room Interface	8300					
Serial Communication Option							
	No communication (select when using LoraWan)	0					
MOD	Modbus RS485	1					
BAC	BACnet MS/TP	2					
Wireless Communication Options							
	No Interface	00					
BLE	Bluetooth App Interface	03					
LRA	LoraWan Wireless Interface (select Lora region below)	06					
BLE-LRA	Bluetooth App Interface and LoraWan Wireless Interface (select Lora region)	09					
Zone Sensor Supply							
	USB-C Connector				60		
5V	5V+ Zone Sensor Communications with Screw Wiring Terminals				61		
E	Optional Extra Wiring Terminals for Looping				62		
5VE	Screw Wiring Terminals for Zone Sensors + Extra Wiring Terminals				63		
Power Supply Option							
24	24V Power Supply					10	
230	230V Power Supply, 24Vac 8VA available for actuators					11	
Region Options (Lora)							
	Non Lora & EU868MHz Lora (Default)						0
US	US915MHz Lora						1
AS	AS923MHz Lora						2
Colour Options							
W	White						2

Part Number	Description	SKU# Number
Accessories		
USB-C-CAB-6	6m USB-C Male to USB-C Male for Room Interface Units, Black	8510 0 00 0005 01
USB-C-EXT-6	5m USB-C Female to USB-C Male Extension Cable, Black	8520 0 00 0006 01

Wiring Connections

TCR81 WIRING CONNECTIONS

The diagram below illustrates the wiring connections to the TCR81 controllers.

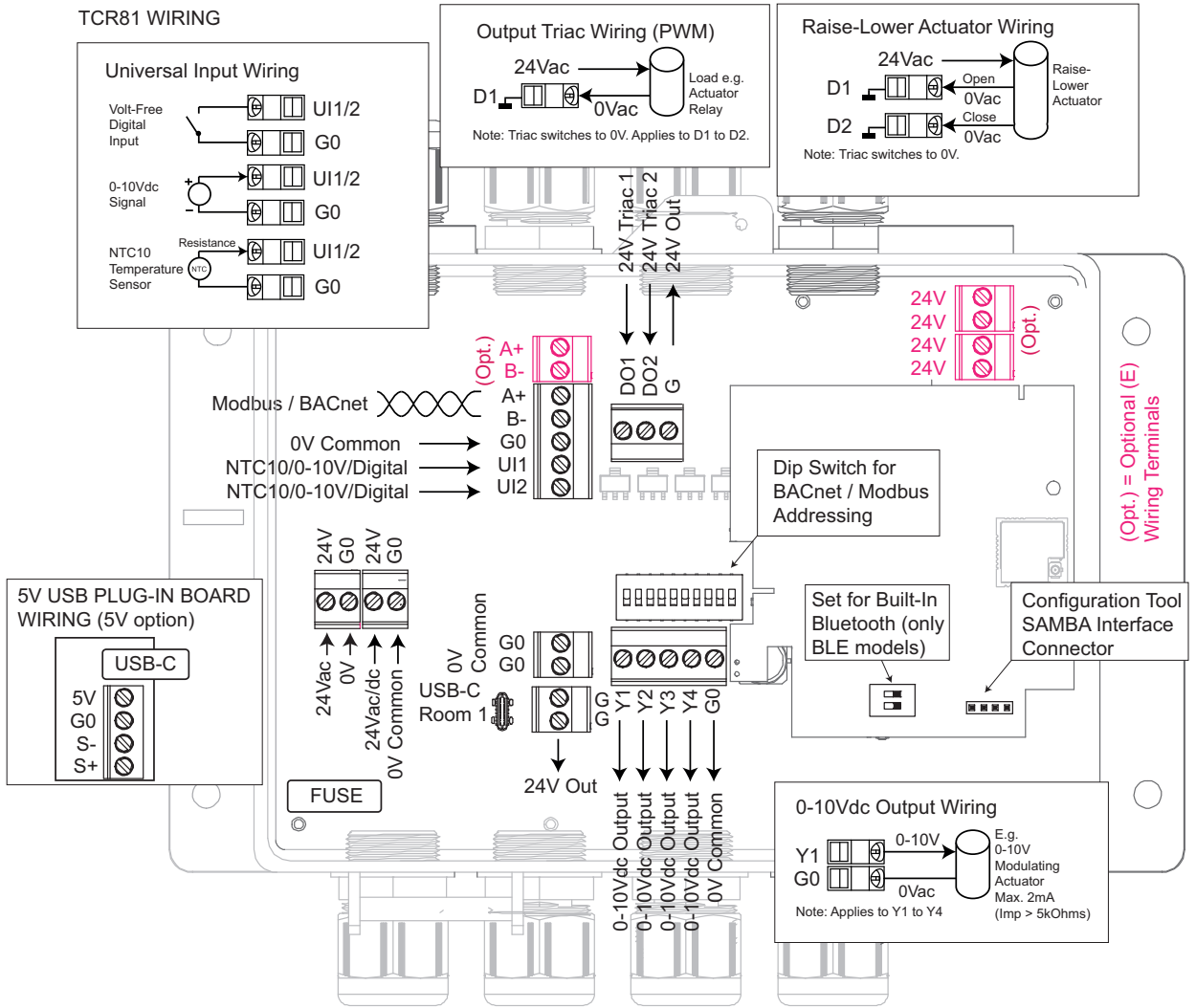

Terminal	Description
A+	Modbus / BACnet RS485 A+
B-	Modbus / BACnet RS485 B-
G0	0V Common
UI1	NTC10/0-10V/Volt-Free Digital Input 1
UI2	NTC10/0-10V/Volt-Free Digital Input 2
24V	24Vac Supply (Before Fuse)
G0	0V Common
G0	0V Common
G	24Vac Output (Fused)

Terminal	Description
D01	24Vac Triac, Max 1A
D02	24Vac Triac, Max 1A
G	24Vac Output
G	24Vac Output
Y1	0-10Vdc Output max. 2mA
Y2	0-10Vdc Output max. 2mA
Y3	0-10Vdc Output max. 2mA
Y4	0-10Vdc Output max. 2mA
G0	0V Common

TCR82 WIRING CONNECTIONS

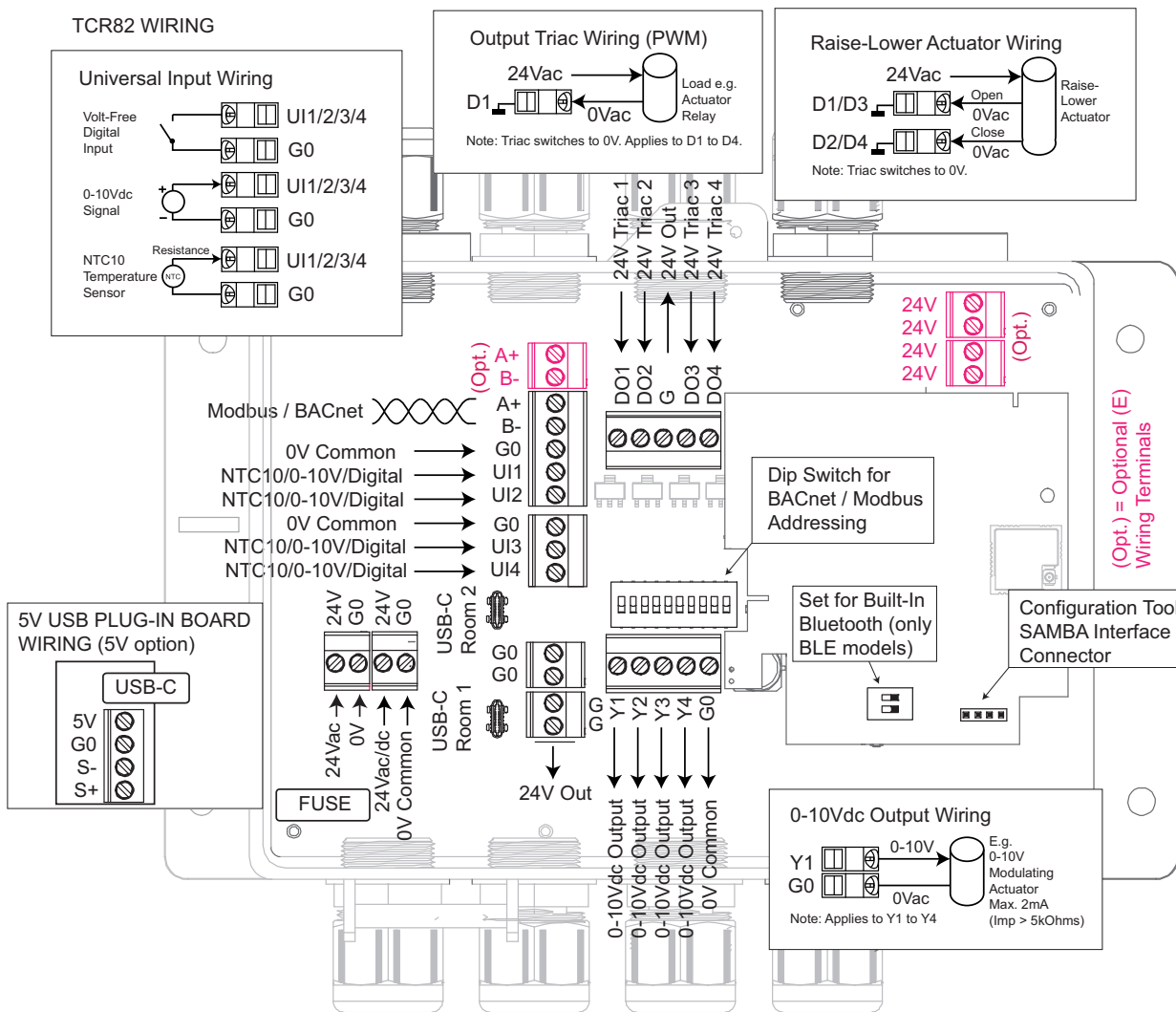

Terminal	Description
A+	Modbus / BACnet RS485 A+
B-	Modbus / BACnet RS485 B-
G0	0V Common
UI1	NTC10/0-10V/Volt-Free Digital Input 1
UI2	NTC10/0-10V/Volt-Free Digital Input 2
G0	0V Common
UI3	NTC10/0-10V/Volt-Free Digital Input 3
UI4	NTC10/0-10V/Volt-Free Digital Input 4
24V	24Vac Supply (Before Fuse)
G0	0V Common
G0	0V Common
G	24Vac Output (Fused)

Terminal	Description
D01	24Vac Triac, Max 1A
D02	24Vac Triac, Max 1A
G	24Vac Output
D03	24Vac Triac, Max 1A
D04	24Vac Triac, Max 1A
G	24Vac Output
Y1	0-10Vdc Output max. 2mA
Y2	0-10Vdc Output max. 2mA
Y3	0-10Vdc Output max. 2mA
Y4	0-10Vdc Output max. 2mA
G0	0V Common

TCR83 WIRING CONNECTIONS

TCR83 WIRING

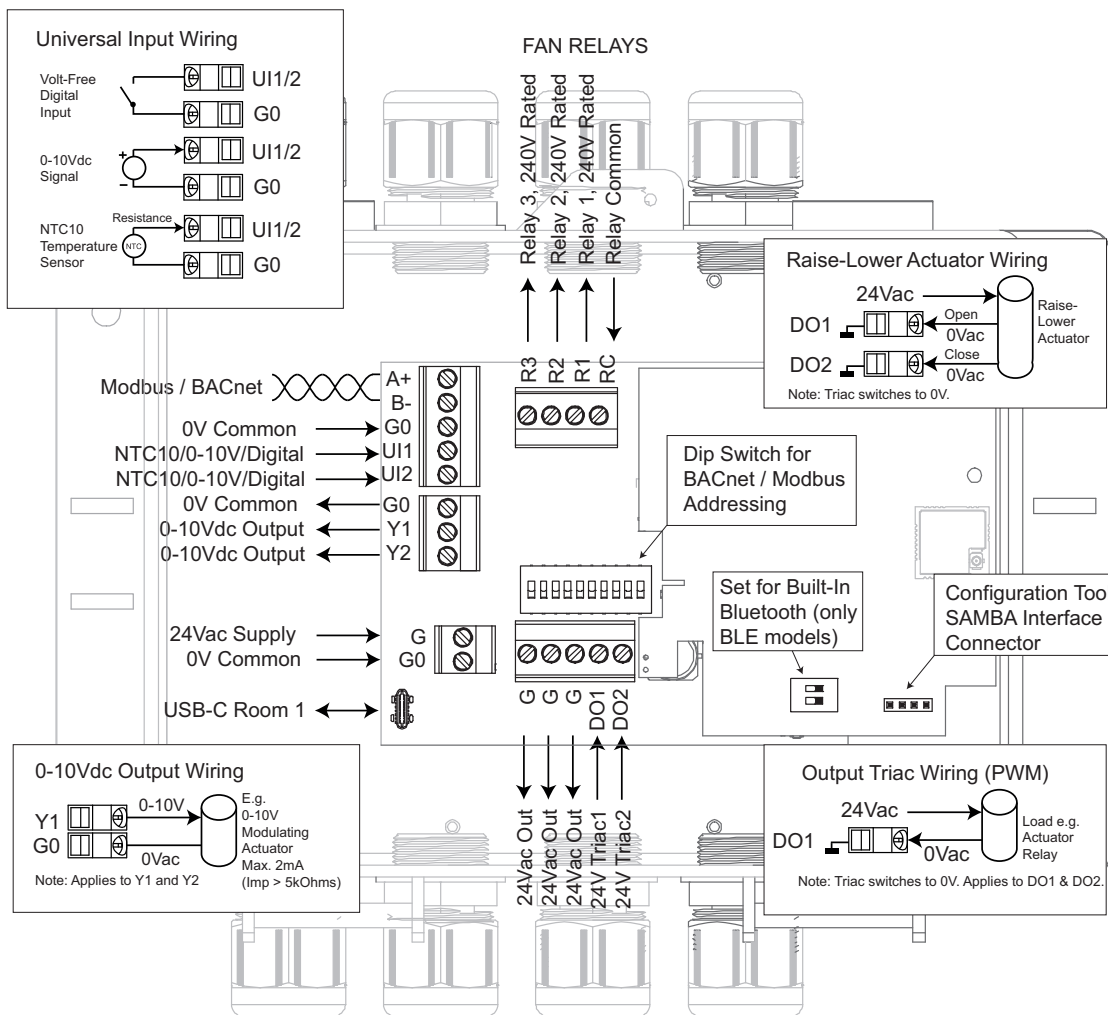

Terminal	Description
A+	Modbus / BACnet RS485 A+
B-	Modbus / BACnet RS485 B-
G0	0V Common
UI1	NTC10/0-10V/Volt-Free Digital Input 1
UI2	NTC10/0-10V/Volt-Free Digital Input 2
G0	0V Common
Y1	0-10Vdc Output max. 2mA
Y2	0-10Vdc Output max. 2mA
G	24Vac -10/+15% Supply
G0	0V Common

Terminal	Description
RC	Relay Common, Max 3A
R1	250VAC Relay 1, Max 90W
R2	250VAC Relay 2, Max 90W
R3	250VAC Relay 3, Max 90W
G	24Vac Output
G	24Vac Output
G	24Vac Output
D01	24Vac Triac, Max 1A
D02	24Vac Triac, Max 1A

NOTE: The fan relays (R1, R2 and R3) are interlocked, only one relay is active any given time.

WIRING GUIDELINES

Make sure that power is switched off and carry out wiring according to the wiring connections drawing and local wiring guidelines.

Room Display Interfaces

The TCR80 series controllers are complemented with the TDR/QDR20 series room display interfaces (up to 2 zones). TDR20/QDR20 interfaces offer measurement of temperature, CO2, humidity, VOC and occupancy (movement). The interfaces allow the user to adjust the temperature setpoint, fan speed, operating mode and also boost the operation. The interfaces can be also used to convey the TCR80 series controller status information as well as utility meter information to the user. The diagram below illustrates the setup.

TCR80 SERIES NETWORK DIAGRAM

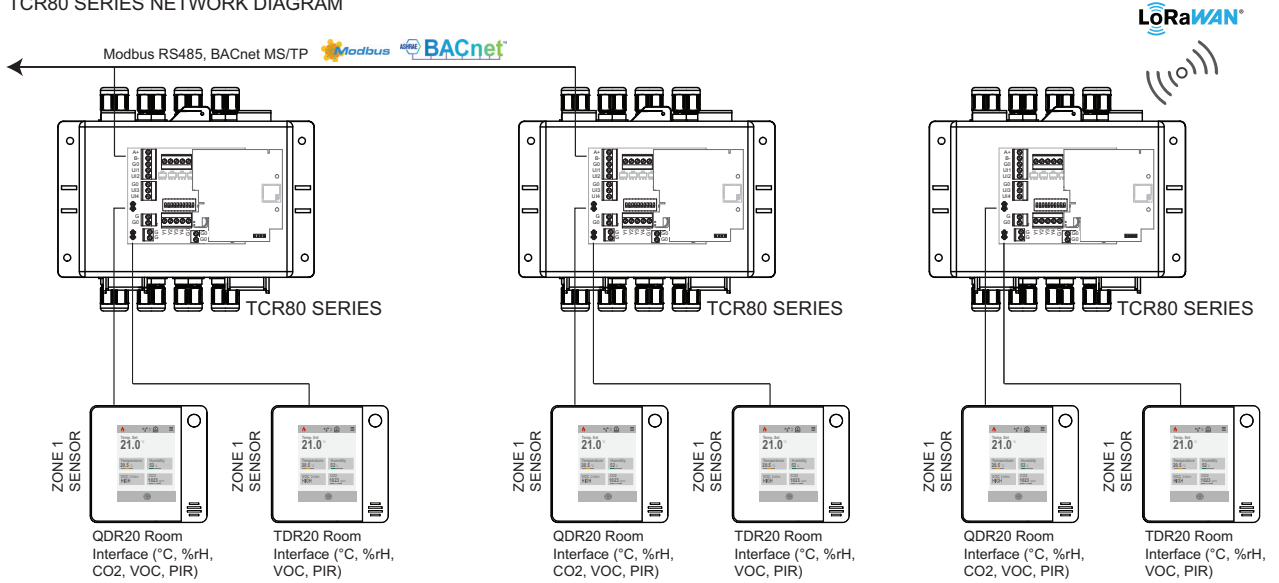

The TCR80 series controllers communicate to the TDR/QDR20 room interfaces using Modbus communication protocol. Zone 1 interface uses Address 1 and Zone 2 interface uses address 2. After connecting the zone interface via USB-C cable (or through optional wiring terminals, 5V option), activate the interface from the System settings.

The TCR80 series controllers read the following measurements from the TDR/QDR20 Devices.

Parameter	Description	TCR Zone 1 Regs	TCR Zone 2 Regs
ZONE MEASUREMENTS			
Temperature Sensor	TDR/QDR temperature measurement.	400	405
Humidity Sensor	TDR/QDR humidity measurement.	401	406
CO2 Sensor	QDR CO2 reading.	402	407
VOC Sensor	TDR/QDR VOC (Volatile Organic Compound) Index Value	403	408
Dew Point	Calculated Dew Point (calculated at TCR80)	404	409

TCR80 controllers can operate up to two control zones. These control zones use the measurements and overrides from the zone sensors (if enabled). These include the following:-

Parameter	Description	TCR Zone 1 Regs	TCR Zone 2 Regs
Calculated Setpoint	Current Calculated Setpoint for the Zone (can be adjusted from the zone sensor)	420	430
Control Mode	Current Control Mode for the Zone (can be changed from the TDR20/QDR20 interface)	423	433
Fan Mode	Current Fan Level / Control Mode. Manual Off - Manual Speed 1 - Manual Speed 2, Manual Speed 3 or Automatic	429	439

Each Zone Sensor (TDR20/QDR20) can be used to display additional information such as outside air temperature, water and energy consumption figures. These values can be changed via the following registers.

Parameter	Description	TCR Zone 1 Regs	TCR Zone 2 Regs
Network Value 1	Network Value 1 (for displaying network single decimal value).	600	602
Network Value 2	Network Value 2 (for displaying network integer value).	601	603

WIRING TO ROOM INTERFACES

Using USB-C Cable

**SENSOR BUS CONNECTION TO TDR20/QDR20
USING USB-C CABLE**

Note: Sensor bus uses RS485 over USB-C cable
(requires full USB-C cable e.g. Senticon USB-C-CAB-6)

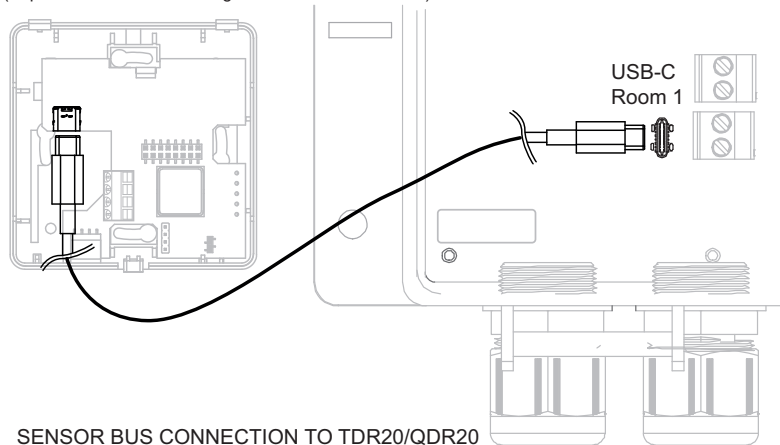
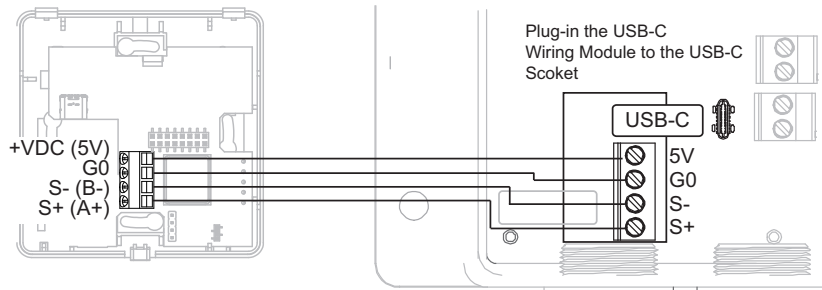
**SENSOR BUS CONNECTION TO TDR20/QDR20
USING WIRES****Control Functions**

TCR80 series controllers have flexible control functionality to control up to two control zones, with temperature, CO₂, humidity, VOC and occupancy control. The full functionality is achieved by connecting TDR/QDR20 Room Display Interfaces. TCR81 series controllers support one TDR/QDR20 interface whereas TCR82 series support two Room Display Interfaces. The TCR80 series controllers have duplicate functionality for both zone 1 and 2.

ZONE 1 AND ZONE 2 CONTROL MODES

Both Zone 1 and Zone 2 have three control modes:-

- Occupied (Comfort)
- Unoccupied (Relaxed)
- Off (Night)

The controller operating mode is changed via Modbus/BACnet network, via Universal Inputs or via corresponding TDR20/QDR20 Touchscreen Room Interface Unit (Status read from Modbus Slave 1/2, Reg 424, written to Reg 604). The TDR/QDR20 Room Display Interfaces allow the user to change the operating mode via the display, or if the Interface has been fitted with Occupancy sensor, the occupancy detection can change the mode.

On transition from Occupied to Unoccupied/Off modes the Multi-Stage, Auxiliary and Humidity Loop user setpoint adjustments can be automatically reset to nominal values (enable *Reset User Adjustment* parameter 684 / 2684)

NOTE: The control mode change happens when the controller sees the transition on the state of the command signal. This means that e.g if Digital Input 1 (U1) overrides the controller to unoccupied mode, the mode can be changed e.g. via network regardless of the current DI1 state.

The control loop outputs (demand signals) are set in different modes as per the below table. Each zone has corresponding control loops and control loop outputs.

Control Mode	Zone 1 and Zone 2 Heating and Cooling Stages 1/2/3 Demand	Air Quality CO2 and VOC Control Demand	Humidity and Dehumidty Control Demand, Fan Demand
Occupied	Based on control loop with occupied deadzone settings	Based on control loop	Based on control loop
Unoccupied	Based on control loop with unoccupied deadzone settings	Based on control loop	Based on control loop
Off	0% (Frost logic enables heating stages to 100%)	0%	0%

NOTE: On power up the controller both zones start in Occupied (Comfort) mode.

ZONE 1 AND ZONE 2 MULTI-STAGE TEMPERATURE CONTROL

The each zone of the controller has a multi-stage temperature control logic that meets requirements for advanced temperature control applications using PI-control (Proportional + Integral). Up to three (3) heating and up to three (3) cooling stages are available. Between the heating and cooling stages is a dead-zone where the heating and cooling outputs modulate to closed position providing energy savings in the building when the temperature reaches the setpoint. The heating and cooling deadzones can be separately set to provide asymmetrical control for increased energy savings.

The temperature control is operating in Occupied (comfort) / Unoccupied and Off modes. In unoccupied mode the temperature control is relaxed by increasing the heating and cooling deadzones. In the Off mode the temperature control is switched off (with frost protection active).

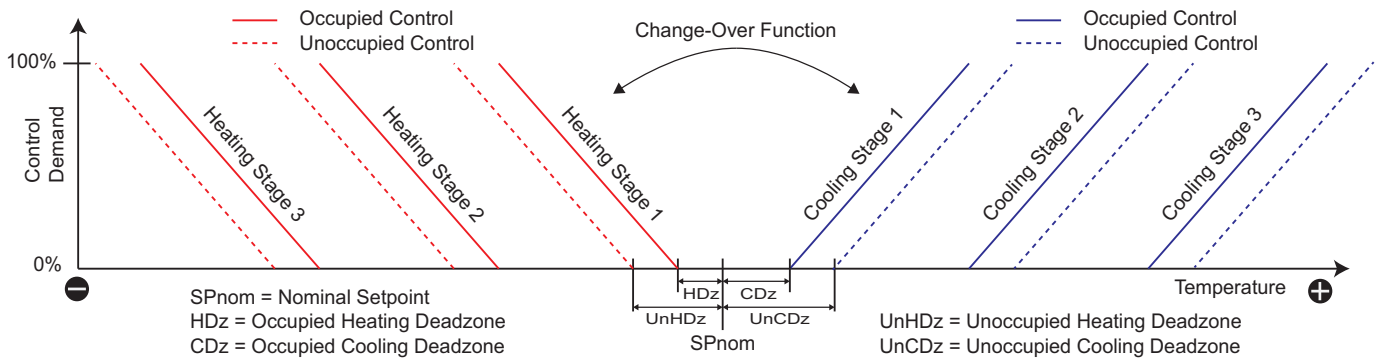

The multi-stage temperature control loops (Zone 1 and Zone 2) can be configured to control Universal Input 1/2/3/4 temperature/voltage, network value (network temperature), TVD/QDR20 Room Display Temperature or average temperature.

NOTE: TDR20/QDR20 Device ID 1 is automatically linked to Zone 1 (Modbus Slave 1) and Device ID 2 (Modbus Slave 2) is automatically linked to Zone 2.

NOTE: Corresponding TDR20/QDR20 Room Display Interface is required to be activated in the System Settings menu.

The each zone's control loop controls to the Calculated Setpoint. The calculated setpoint is set to nominal setpoint when the nominal setpoint is changed over the Modbus/BACnet network. If the user changes the setpoint on the Room Display (Modbus Reg 418), the new setpoint is automatically read to the TCR80 series controller. In case the Room Display for the Zone 1 is active, and the BMS changes the nominal setpoint, this is also sent to the Room Display.

NOTE: *Source: Network value* can only be used in systems where the measurement changes slowly.

FROST PROTECTION (OFF MODE)

In the Night Off mode, the controller automatically monitors the control sensor for low temperature protection (Frost Setpoint). If temperature drops below the frost setpoint, the heating stages for the zone are switched on to 100% until temperature rises 2° above the Frost Setpoint.

Parameter	Description	Value Range / Enumerations
ZONE 1 PARAMETERS		
Z1 Loop Source	<p>Sets the Control Source for the Multi-Stage Control Loop for Zone 1.</p> <p>Zone 1 Temperature is read from the Room Device 1 (Modbus Slave 1, Reg 400).</p> <p>Note: If UI mode is NTC, the control value is as measured temperature. If the UI mode is 0-10V, then 0..10V is scaled to measurement according to UI Input Min/Max scaling parameters.</p> <p>Average Function allows temperature averaging.</p>	<p>0 = Network Value (Reg 600)</p> <p>1 = Zone Temperature (Default)</p> <p>2 = UI1 - NTC10</p> <p>3 = UI2 - NTC10</p> <p>4 = UI3 - NTC10</p> <p>5 = UI4 - NTC10</p> <p>6 = UI1 - 0..10Vdc</p> <p>7 = UI2 - 0..10Vdc</p> <p>8 = UI3 - 0..10Vdc</p> <p>9 = UI4 - 0..10Vdc</p> <p>10 = Average Value</p>
Z1 Nominal Setpoint	<p>Zone 1 Control Loop Nominal Setpoint</p> <p>Note: The control loop setpoint can be shifted by the high/low limit reset function.</p>	0.0..3200.0 (Default 21.0)
Z1 Loop PB	Zone 1 Control Loop Proportional Band (for each stage)	1..3200 (Default 5)
Z1 IA	Zone 1 Control Loop Integral Action Time (Set to 0 to disable)	0..3600s (Default 600s)
Z1 No of Heating Stages	Sets the number of heating stages for Zone 1.	<p>0 = None</p> <p>1 = 1-Stage (Default)</p> <p>2 = 2-Stages</p> <p>3 = 3-Stages</p>
Z1 No of Cooling Stages	Sets the number of cooling stages for Zone 1.	<p>0 = None</p> <p>1 = 1-Stage (Default)</p> <p>2 = 2-Stages</p> <p>3 = 3-Stages</p>
Z1 Occupied Heating Deadzone (HDz)	Occupied Mode Heating Deadzone for Zone 1.	0.0..30.0 (Default 0.5)
Z1 Occupied Cooling Deadzone (CDz)	Occupied Mode Cooling Deadzone for Zone 1.	0.0..30.0 (Default 0.5)
Z1 Unoccupied Heating Deadzone (UnHDz)	Unoccupied Mode Heating Deadzone for Zone 1.	0.0..30.0 (Default 3.0)
Z1 Unoccupied Cooling Deadzone (UnCDz)	Unoccupied Mode Cooling Deadzone for Zone 1.	0.0..30.0 (Default 3.0)
Z1 Frost Setpoint	Off Mode Frost Setpoint for Zone 1	0.0..60.0 (Default 10.0)

Parameter	Description	Value Range / Enumerations
ZONE 2 PARAMETERS		
Z2 Loop Source	<p>Sets the Control Source for the Multi-Stage Control Loop for Zone 2.</p> <p>Zone Temperature is read from the Room Display 2 (Modbus Slave 2, Reg 400)</p> <p>Note: If UI mode is NTC, the control value is as measured temperature. If the UI mode is 0-10V, then 0..10V is scaled to measurement according to UI Input Min/Max scaling parameters.</p> <p>Average Function allows temperature averaging.</p>	<p>0 = Network Value (Reg 602)</p> <p>1 = Zone Temperature (Default)</p> <p>2 = UI1 - NTC10</p> <p>3 = UI2 - NTC10</p> <p>4 = UI3 - NTC10</p> <p>5 = UI4 - NTC10</p> <p>6 = UI1 - 0..10Vdc</p> <p>7 = UI2 - 0..10Vdc</p> <p>8 = UI3 - 0..10Vdc</p> <p>9 = UI4 - 0..10Vdc</p> <p>10 = Average Function</p>
Z2 Nominal Setpoint	<p>Zone 2 Control Loop Nominal Setpoint</p> <p>Note: The control loop setpoint can be shifted by the high/low limit reset function.</p>	0.0..3200.0 (Default 21.0)
Z2 Loop PB	Zone 2 Control Loop Proportional Band (for each stage)	1..3200 (Default 5)
Z2 IA	Zone 2 Control Loop Integral Action Time (Set to 0 to disable)	0..3600s (Default 600s)
Z2 No of Heating Stages	Sets the number of heating stages for Zone 2.	<p>0 = None</p> <p>1 = 1-Stage (Default)</p> <p>2 = 2-Stages</p> <p>3 = 3-Stages</p>

Z2 No of Cooling Stages	Sets the number of cooling stages for Zone 2.	0 = None 1 = 1-Stage (Default) 2 = 2-Stages 3 = 3-Stages
Z2 Occupied Heating Deadzone (HDz)	Occupied Mode Heating Deadzone for Zone 2.	0.0..30.0 (Default 0.5)
Z2 Occupied Cooling Deadzone (CDz)	Occupied Mode Cooling Deadzone for Zone 2.	0.0..30.0 (Default 0.5)
Z2 Unoccupied Heating Deadzone (UnHDz)	Unoccupied Mode Heating Deadzone for Zone 2.	0.0..30.0 (Default 3.0)
Z2 Unoccupied Cooling Deadzone (UnCDz)	Unoccupied Mode Cooling Deadzone for Zone 2.	0.0..30.0 (Default 3.0)
Z2 Frost Setpoint	Off Mode Frost Setpoint for Zone 2	0.0..60.0 (Default 10.0)

NOTE: If Change-Over function is activated, it can override the Heating Stage1 to operate as Cooling Stage1.

NOTE: Proportional Band is for each stage. E.g. if 3-stages of heating had been selected, and if the Proportional Band has been set as 5, then the Proportional Band across 3-stages of heating is 15.

ZONE 1 AND ZONE 2 CHANGE-OVER FUNCTION

The controller can have a change-over function for each zone that reverses the corresponding temperature control loop Heating Stage1 (and Cooling Stage1) operation.

The change-over function is activated by the digital input (UI1/UI2/UI3/UI4 digital input), via temperature (UI1/UI2/UI3/UI4 NTC10 temperature), or via network. If temperature is selected, the change-over is active (cooling mode is active) if temperature drops below the change-over low temperature until temperature reaches the change-over high temperature (heating mode becomes active).

Parameter	Description	Value Range / Enumerations
ZONE 1 PARAMETERS		
Z1 Change-Over Source	Sets the Source for the Zone 1 Change-Over Function. Note: As default the Network Command is Off i.e. no change-over function is active. Note: When using Digital Inputs set the corresponding universal input mode to '5 - Digital Network'.	0 = Network Command 1 = UI1 - NTC10 2 = UI2 - NTC10 3 = UI3 - NTC10 4 = UI4 - NTC10 5 = Digital Input 1 (UI1) 6 = Digital Input 2 (UI2) 7 = Digital Input 3 (UI3) 8 = Digital Input 4 (UI4)
Z1 Change-Over Low Level	Temperature below which the change-over is active for Zone 1 (cooling stage active). Note: Relevant only for NTC Input 1/2/3/4 options.	0..100.0° (32..212°F) Default 18°C
Z1 Change-Over High Level	Temperature above which the change-over is off for Zone 1 (heating stage active, no override on control). Note: Relevant only for NTC Input 1/2/3/4 options.	0..100.0° (32..212°F) Default 22°C
Z1 Network Change-Over Override	Heating / Cooling Mode Command from Network for Zone 1. Note: Requires change-over source to be set as Network.	0 = Heating (Default) 1 = Cooling

Parameter	Description	Value Range / Enumerations
ZONE 2 PARAMETERS		
Z2 Change-Over Source	Sets the Source for the Zone 2 Change-Over Function. Note: As default the Network Command is Off i.e. no change-over function is active. Note: When using Digital Inputs set the corresponding universal input mode to '5 - Digital Network'.	0 = Network Command 1 = UI1 - NTC10 2 = UI2 - NTC10 3 = UI3 - NTC10 4 = UI4 - NTC10 5 = Digital Input 1 (UI1) 6 = Digital Input 2 (UI2) 7 = Digital Input 3 (UI3) 8 = Digital Input 4 (UI4)

Z2 Change-Over Low Level	Temperature below which the change-over is active for Zone 2 (cooling stage active). Note: Relevant only for NTC Input 1/2/3/4 options.	0..100.0° (32..212°F) Default 18°C
Z2 Change-Over High Level	Temperature above which the change-over is off for Zone 2 (heating stage active, no override on control). Note: Relevant only for NTC Input 1/2/3/4 options.	0..100.0° (32..212°F) Default 22°C
Z2 Network Change-Over Override	Heating / Cooling Mode Command from Network for Zone 2. Note: Requires change-over source to be set as Network.	0 = Heating (Default) 1 = Cooling

NOTE: Change-over function is not active in Off Mode.

TIP: Typically configure the control output (Y1 to Y4) to Z1/Z2 Heating Stage1. In normal operation the output provides heating control (i.e. when temperature is below setpoint, there is heating demand). When the change-over is active, the same output provides cooling control (i.e. when temperature is above setpoint, there is cooling demand).

ZONE 1 AND ZONE 2 LOW/HIGH LIMIT RESET (CASCADE) CONTROL FUNCTION

The controller has a low/high limit reset control function for each zone that is typically used to protect floor surfaces in case of high underfloor heating temperatures, or prevent condensation in case of cool floor temperatures in high humidity environments such as bathrooms.

NOTE: Low/High limit function only applies in Occupied and Unoccupied modes.

Parameter	Description	Value Range / Enumerations
ZONE 1 PARAMETERS		
Z1 Reset Control Source	Sets the Temperature Source for the Reset Control Function for Zone 1.	0 = Network Value (Reg 600) 1= UI1 - NTC10 2 = UI2 - NTC10 3 = UI3 - NTC10 4 = UI4 - NTC10 5 = Disable (Default)
Z1 High Limit Setpoint	High Limit Setpoint for Zone 1. Above this limit the setpoint is reduced proportionally according to the ratio and temperature difference.	0.0..100.0° (32..212°F) Default 35°C
Z1 Low Limit Setpoint	Low Limit Setpoint for Zone 1. Below this limit the setpoint is increased proportionally according to the ratio and temperature difference.	0.0..100.0° (32..212°F) Default 15°C
Z1 Reset Ratio	Reset ratio used to calculated the Zone 1 Multi-Stage Setpoint reset for Zone 1.	0.0..10.0 (Default 1.0)

Parameter	Description	Value Range / Enumerations
ZONE 2 PARAMETERS		
Z2 Reset Control Source	Sets the Temperature Source for the Reset Control Function for Zone 2.	0 = Network Value (Reg 602) 1= UI1 - NTC10 2 = UI2 - NTC10 3 = UI3 - NTC10 4 = UI4 - NTC10 5 = Disable (Default)
Z2 High Limit Setpoint	High Limit Setpoint for Zone 2. Above this limit the setpoint is reduced proportionally according to the ratio and temperature difference.	0.0..100.0° (32..212°F) Default 35°C
Z2 Low Limit Setpoint	Low Limit Setpoint for Zone 2. Below this limit the setpoint is increased proportionally according to the ratio and temperature difference.	0.0..100.0° (32..212°F) Default 15°C
Z2 Reset Ratio	Reset ratio used to calculated the Zone 2 Multi-Stage Setpoint reset for Zone 2.	0.0..10.0 (Default 1.0)

ZONE 1 AND ZONE 2 MAX FUNCTION

Each zone of the controller has two max functions that have two inputs. Using the Max Functions it is possible to, for example, configure how fan is controlled (Max 1 Default Settings), or take maximum of cooling control and CO2 control to control fresh air dampers (Max 2 Default Settings).

Parameter	Description	Value Range / Enumerations
ZONE 1 PARAMETERS		
Z1 Max Function 1 Source 1	Sets the Source for Input 1 of Z1 Maximum Function 1 Default: Heating Stage 1	0 = Network Value (Reg 600)
Z1 Max Function 1 Source 2	Sets the Source for Input 2 of Z1 Maximum Function 1 Default: Cooling Stage 1	1 = Z1 Heating Stage 1 2 = Z1 Heating Stage 2 3 = Z1 Heating Stage 3
Z1 Max Function 2 Source 1	Sets the Source for Input 1 of Z1 Maximum Function 2 Default: Cooling Stage 1	4 = Z1 Cooling Stage 1 5 = Z1 Cooling Stage 2
Z1 Max Function 2 Source 2	Sets the Source for Input 2 of Z1 Maximum Function 2 Default: CO2 Demand	6 = Z1 Cooling Stage 3 7 = Z1 CO2 Demand 8 = Z1 VOC / AUX Demand 9 = Z1 Humidity/DeHum Demand 10 = Z1 Max Function 1 11 = Z1 Max Function 2 12 = Z1 Fan Demand
ZONE 2 PARAMETERS		
Z2 Max Function 1 Source 1	Sets the Source for Input 1 of Z2 Maximum Function 1 Default: Heating Stage 1	0 = Network Value (Reg 602)
Z2 Max Function 1 Source 2	Sets the Source for Input 2 of Z2 Maximum Function 1 Default: Cooling Stage 1	1 = Z2 Heating Stage 1 2 = Z2 Heating Stage 2 3 = Z2 Heating Stage 3
Z2 Max Function 2 Source 1	Sets the Source for Input 1 of Z2 Maximum Function 2 Default: Cooling Stage 1	4 = Z2 Cooling Stage 1 5 = Z2 Cooling Stage 2
Z2 Max Function 2 Source 2	Sets the Source for Input 2 of Z2 Maximum Function 2 Default: CO2 Demand	6 = Z2 Cooling Stage 3 7 = Z2 CO2 Demand 8 = Z2 VOC / AUX Demand 9 = Z2 Humidity/DeHum Demand 10 = Z2 Max Function 1 11 = Z2 Max Function 2 12 = Z2 Fan Demand

EXPLANATION MAX1 DEFAULT OPERATION

As default the Max1 function reads the Heating Stage 1 and Cooling Stage 1 demand values from the Multi-Stage Control loop. Maximum of these values is then used in the fan control loop to set the fan speed (as Fan Control Source = Max Function 1) i.e. the fan is running when there is either heating or cooling demand.

ZONE 1 AND ZONE 2 EC FAN AND 3-SPEED FAN CONTROL

Fan control logic is used to control EC fans and 3-Speed fans. Fan control logic can follow Continuous or Stepped control. In Continuous control when the source (e.g. heating and cooling demand) increases the fan speed increases linearly between speed settings. The controller has fan control loop for each of the zones.

When under automatic control if the input demand is less than the minimum level (*Min Fan Speed*) the output will be held at the minimum level. The only exception to this is when the *Fan Off Mode* is set to Off and the input demand is 0% in which case the output will be 0%. The *Max Auto Fan Speed* parameter set the maximum fan speed in automatic mode. This can be overdriven manually by setting the *Fan Speed 1/2/3* levels above the *Max Auto Fan Speed*.

In stepped mode the Fan Speed is set in steps (for EC Fans or 3-Speed Fans) with 5% switching OFF hysteresis.

When the fan control source activates (increases above 0%) the Fan Speed is switched to '*Fan Speed 1*' Level for adjustable delay time ('*Fan Startup Delay*') regardless of the *Min Fan Speed* setting. This allows EC Fans to start to run properly before resuming normal control.

If the *Fan Off Mode* setting is set to Off, the Fan output switches OFF after an adjustable '*Fan Off Delay*' Time.

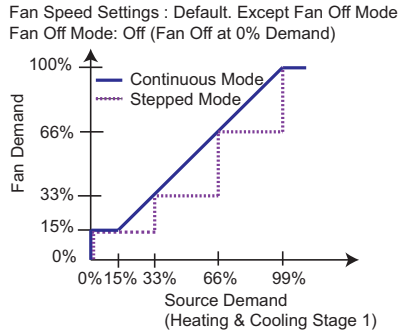
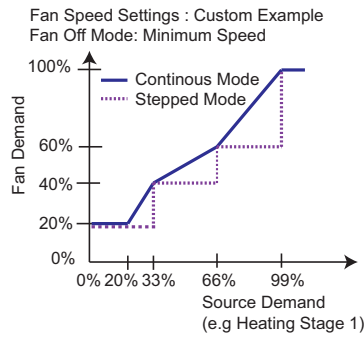
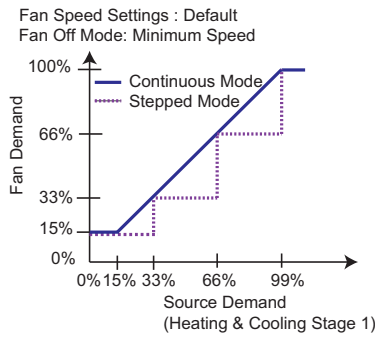

Parameter	Description	Value Range / Enumerations
ZONE 1 PARAMETERS		
Z1 Fan Control Source	Sets the Source Demand for the Z1 Fan Control Function.	0 = Network Value (Reg 600) 1 = Z1 Heating Stage 1 2 = Z1 Heating Stage 2 3 = Z1 Heating Stage 3 4 = Z1 Cooling Stage 1 5 = Z1 Cooling Stage 2 6 = Z1 Cooling Stage 3 7 = Z1 CO2 Demand 8 = Z1 VOC / AUX Demand 9 = Z1 Humidity/DeHum Demand 10 = Z1 Max Function 1 (Default) 11 = Z1 Max Function 2
Z1 Min Fan Speed	Sets the Z1 Minimum Fan Speed for EC Fans	0..100% (Default 15%)
Z1 Fan Speed 1	Sets the Z1 Fan Speed 1 for EC Fans (when source 33%)	0..100% (Default 33%)
Z1 Fan Speed 2	Sets the Z1 Fan Speed 2 for EC Fans (when source 66%)	0..100% (Default 66%)
Z1 Fan Speed 3	Sets the Z1 Fan Speed 3 for EC Fans (when source 99%)	0..100% (Default 100%)
Z1 Fan Mode	Sets the Z1 EC Fan Mode. Continuous Mode scales the fan demand based on the source and Fan Speed 1/2/3 settings. In Stepped mode the fan speed steps according to Fan Speed 1/2/3 settings. In stepped mode the Fan Speed switching hysteresis is 5%.	0 = Continuous Mode (Default) 1 = Stepped Mode
Z1 Fan Off Mode	Configures if the Fan is running at minimum level or is off when the fan control demand is at 0% for Z1.	0 = Off (Default) 1 = Minimum Speed
Z1 Fan Off Delay	Switch OFF delay when the source demand drops to 0 (and Fan Off Mode is set to Off) for Z1	0..600 seconds (Default 0)
Z1 Fan Startup Delay	Z1 Fan Startup when the source demand increases above 0%. During the delay the fan runs at Fan Speed 1 setting.	0..600 seconds (Default 10)
Z1 Fan Level Override	Z1 Current Fan Level that can be set from the network. The value is also automatically sent to the corresponding Room Display Interface.	0 = Off 1 = Level 1 2 = Level 2 3 = Level 3 4 = Automatic
Z1 Max Auto Fan Speed	Z1 Maximum Fan Speed in Automatic Control Mode	0..100% (Default 100%)

Parameter	Description	Value Range / Enumerations
ZONE 2 PARAMETERS		
Z2 Fan Control Source	Sets the Source Demand for the Z2 Fan Control Function.	0 = Network Value (Reg 602) 1 = Z2 Heating Stage 1 2 = Z2 Heating Stage 2 3 = Z2 Heating Stage 3 4 = Z2 Cooling Stage 1 5 = Z2 Cooling Stage 2 6 = Z2 Cooling Stage 3 7 = Z2 CO2 Demand 8 = Z2 VOC / AUX Demand 9 = Z2 Humidity/DeHum Demand 10 = Z2 Max Function 1 (Default) 11 = Z2 Max Function 2
Z2 Min Fan Speed	Sets the Z2 Minimum Fan Speed for EC Fans	0..100% (Default 15%)
Z2 Fan Speed 1	Sets the Z2 Fan Speed 1 for EC Fans (when source 33%)	0..100% (Default 33%)
Z2 Fan Speed 2	Sets the Z2 Fan Speed 2 for EC Fans (when source 66%)	0..100% (Default 66%)
Z2 Fan Speed 3	Sets the Z2 Fan Speed 3 for EC Fans (when source 99%)	0..100% (Default 100%)
Z2 Fan Mode	Sets the Z2 EC Fan Mode. Continuous Mode scales the fan demand based on the source and Fan Speed 1/2/3 settings. In Stepped mode the fan speed steps according to Fan Speed 1/2/3 settings. In stepped mode the Fan Speed switching hysteresis is 5%.	0 = Continuous Mode (Default) 1 = Stepped Mode
Z2 Fan Off Mode	Configures if the Fan is running at minimum level or is off when the fan control demand is at 0% for Z2.	0 = Off (Default) 1 = Minimum Speed
Z2 Fan Off Delay	Switch OFF delay when the source demand drops to 0 (and Fan Off Mode is set to Off) for Z2	0..600 seconds (Default 0)
Z2 Fan Startup Delay	Z2 Fan Startup when the source demand increases above 0%. During the delay the fan runs at Fan Speed 1 setting.	0..600 seconds (Default 10)
Z2 Fan Level Override	Z2 Current Fan Level that can be set from the network. The value is also automatically sent to the corresponding Room Display Interface Reg 606.	0 = Off 1 = Level 1 2 = Level 2 3 = Level 3 4 = Automatic
Z2 Max Auto Fan Speed	Z2 Maximum Fan Speed in Automatic Control Mode	0..100% (Default 100%)

MANUAL FAN SPEED CONTROL

If TDR20/QDR20 Room Display Interface is connected to the controller, the TCR80 controller reads the current fan level from the Room Display and sets the fan control logic to follow this. In essence values 0..3 are indicating manual fan speed overrides (no automatic control), and value 4 indicates automatic fan speed control..

The Fan Level override parameter (from BMS) allows the fan speed to be overridden from the network. If this value is changed, it will also be sent to the TDR20/QDR20 room interface device.

NOTE: The TCR83 controllers have 3 x 230V Fan Relays. The Y3 is inter-connected to the fan relays. Relay 1 comes on at approximately 30%, relay 2 at 65% and relay 3 at 99%. Configure Y3 to follow the Z1 Fan Speed, for the fan relays to follow the fan speed control logic.

ZONE 1 AND ZONE 2 CO2 (CARBON DIOXIDE) CONTROL

TCR80 series provides CO2 control loop for each zone using PI (Proportional + Integral) control logic. The control loop output can be connected to the physical outputs to e.g. control the fresh air damper using analogue outputs.

The CO2 measurement can be read from the QDR20 Room Display Interface, from Universal Input or from the network.

With Proportional Control when the CO2 measurement increases above the CO2 Setpoint, the CO2 control demand (and control output) increases proportionally based on the Proportional Band (PB) setting - see image.

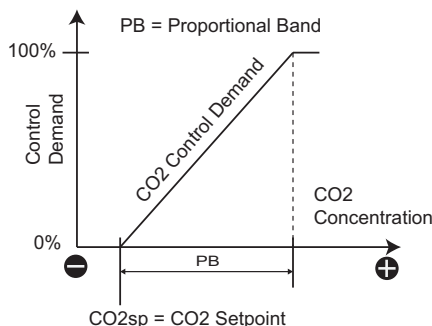

Often fresh air damper is also used to provide cool air to the building. In this case the damper is linked to both Cooling Stage temperature control and CO2 control. This can be achieved using so called 'Maximum VAV' logic. With TCR80 Series the Max Function can be used to take the maximum of Cooling and CO2 demands and link it to an output (*Max Function 2* is configured as default for this for Zones 1 and 2).

Parameter	Description	Value Range / Enumerations
ZONE 1 PARAMETERS		
Z1 CO2 Control Source	Sets the Source for the CO2 Control for Zone 1 Zone CO2 Measurement is from Room Display Interface 1. Note: If set to UI1/UI2/UI3/UI4, then 0..10V is scaled to measurement according to UI Input Min/Max scaling parameters.	0 = Network Value (Reg 601) 1 = Zone CO2 Measurement (Default) 2 = UI1 - 0..10V 3 = UI2 - 0..10V 4 = UI3 - 0..10V (TCR82) 5 = UI4 - 0..10V (TCR82)
Z1 CO2 Setpoint	CO2 Control Setpoint for Zone 1	0..10,000 (Default 750)
Z1 CO2 PB	CO2 Control Proportional Band for Zone 1	1..10,000 (Default 500)
Z1 CO2 IA	CO2 Control Integral Action Time (Set to 0 to disable) for Zone 1	0..3600s (Default 0s)
Z1 CO2 Setpoint Setback	CO2 Control Setpoint SetBack in Unoccupied mode	0..2,000 (Default 0)
Z1 CO2 Control Mode	CO2 Control Loop Operation Direction	0 = Reverse 1 = Direct (Default)
ZONE 2 PARAMETERS		
Z2 CO2 Control Source	Sets the Source for the CO2 Control for Zone 2 Zone CO2 Measurement is from Room Display Interface 2 (Modbus Slave 2, Reg 402) Note: If set to UI1/UI2/UI3/UI4, then 0..10V is scaled to measurement according to UI Input Min/Max scaling parameters.	0 = Network Value (Reg 603) 1 = Zone CO2 Measurement (Default) 2 = UI1 - 0..10V 3 = UI2 - 0..10V 4 = UI3 - 0..10V (TCR82) 5 = UI4 - 0..10V (TCR82)
Z2 CO2 Setpoint	CO2 Control Setpoint for Zone 2	0..10,000 (Default 750)
Z2 CO2 PB	CO2 Control Proportional Band for Zone 2	1..10,000 (Default 500)
Z2 CO2 IA	CO2 Control Integral Action Time (Set to 0 to disable) for Zone 2	0..3600s (Default 0s)
Z2 CO2 Setpoint Setback	CO2 Control Setpoint SetBack in Unoccupied mode	0..2,000 (Default 0)
Z2 CO2 Control Mode	CO2 Control Loop Operation Direction	0 = Reverse 1 = Direct (Default)

The *CO2 Setpoint Setback Parameters (764/1764)* allow the CO2 Setpoint to be increased in the Unoccupied mode for the amount set in the parameter 764/1764. For example, the CO2 setpoint can be changed from 750 (default) in Occupied mode to 1000 in the Unoccupied mode by setting *CO2 Setpoint Setback Parameter (764)* to 250 (ppm).

ZONE 1 AND ZONE 2 VOC AIR QUALITY / AUXILIARY CONTROL

TCR80 Series controllers can also control VOC (Organic Volatile Compound). With VOC PI (Proportional + Integral) control logic it is possible to control the air quality by e.g. increasing ventilation on high VOC concentration. The VOC control logic operates in Direct sequence ie. when the VOC Index increases the VOC Control Demand increases proportionally. Each zone VOC measurement is received from the corresponding Room Display Interface, or from Network.

AUXILIARY CONTROL LOOP

The VOC / AUX control loop can also be used controlling e.g. pressure. Setting control loop source to a voltage input, e.g. pressure sensor can be monitored and the controlled.

Parameter	Description	Value Range / Enumerations
ZONE 1 PARAMETERS		
Z1 VOC / AUX Control Source	Sets the Source for the VOC / AUX Control for Zone 1 Zone VOC Measurement is from Room Display Interface 1 (Modbus Slave 1, Reg 403)	0 = Network Value (Reg 601) 1 = Zone VOC Measurement (Default) 2 = UI1 - 0..10V 3 = UI2 - 0..10V 4 = UI3 - 0..10V (TCR82) 5 = UI4 - 0..10V (TCR82)
Z1 VOC / AUX Setpoint	Z1 VOC / AUX Control Setpoint	0..5000 (Default 100)
Z1 VOC/AUX PB	Z1 VOC / AUX Control Proportional Band	1..5000 (Default 100)
Z1 VOC/AUX IA	Z1 VOC / AUX Control Integral Action Time (Set to 0 to disable)	0..3600s (Default 0s)
Z1 VOC / AUX Control Mode	Z1 VOC / AUX Control Loop Operation Direction	0 = Reverse 1 = Direct (Default)
ZONE 2 PARAMETERS		
Z2 VOC /AUX Control Source	Sets the Source for the VOC / AUX Control for Zone 2 Zone VOC Measurement is from Room Display Interface 2 (Modbus Slave 2, Reg 403)	0 = Network Value (Reg 603) 1 = Zone VOC Measurement (Default) 2 = UI1 - 0..10V 3 = UI2 - 0..10V 4 = UI3 - 0..10V (TCR82) 5 = UI4 - 0..10V (TCR82)
Z2 VOC / AUX Setpoint	Z2 VOC / AUX Control Setpoint	0..5000 (Default 100)
Z2 VOC/AUX PB	Z2 VOC / AUX Control Proportional Band	1..5000 (Default 100)
Z2 VOC/AUX IA	Z2 VOC / AUX Control Integral Action Time (Set to 0 to disable)	0..3600s (Default 0s)
Z1 VOC / AUX Control Mode	Z2 VOC / AUX Control Loop Operation Direction	0 = Reverse 1 = Direct (Default)

ZONE 1 AND ZONE 2 HUMIDITY CONTROL

The controller has a single stage humidity / dehumidity PI-control loop that calculates the loop demand based on the TDR/QDR20 humidity measurement or external humidity sensor measurement. Set the *Humidity Mode* to *Humidify* for humidifying action and to *De-Humidify* for dehumidifying action. Humidity measurement is received from the Room Display Interface from corresponding zone, or from Universal Input/Network.

Parameter	Description	Value Range / Enumerations
ZONE 2 PARAMETERS		
Z1 Humidity Source	Sets the Source for the Z1 Humidity Control. Zone Humidity Measurement is from Room Display Interface 1 (Modbus Slave 1, Reg 401) Note: If set to UI1/UI2/UI3/UI4, then 0..10V is scaled to measurement according to UI Input Min/Max scaling parameters.	0 = Network Value (Reg 600) 1 = Zone Humidity Measurement (Default) 2 = UI1 - 0..10V 3 = UI2 - 0..10V 4 = UI3 - 0..10V 5 = UI4 - 0..10V
Z1 Humidity Setpoint	Z1 Humidity Control Loop Setpoint	0..100% (Default 50%)
Z1 Humidity PB	Z1 Humidity Control Proportional Band	1..100% (Default 20%)
Z1 Humidity IA	Z1 Humidity Control Integral Action Time (Set to 0 to disable)	0..3600s (Default 0s)
Z1 Humidity Mode	Z1 Humidity Loop Control Mode	0 = Humidify (Reverse) 1 = De-Humidify (Direct)
ZONE 2 PARAMETERS		

Z2 Humidity Source	Sets the Source for the Z2 Humidity Control. Zone Humidity Measurement is from Room Display Interface 2 (Modbus Slave 2, Reg 401) Note: If set to UI1/UI2/UI3/UI4, then 0..10V is scaled to measurement according to UI Input Min/Max scaling parameters.	0 = Network Value (Reg 602) 1 = Zone Humidity Measurement (Default) 2 = UI1 - 0..10V 3 = UI2 - 0..10V 4 = UI3 - 0..10V 5 = UI4 - 0..10V
Z2 Humidity Setpoint	Z2 Humidity Control Loop Setpoint	0..100% (Default 50%)
Z2 Humidity PB	Z2 Humidity Control Proportional Band	1..100% (Default 20%)
Z2 Humidity IA	Z2 Humidity Control Integral Action Time (Set to 0 to disable)	0..3600s (Default 0s)
Z2 Humidity Mode	Z2 Humidity Loop Control Mode	0 = Humidify (Reverse) 1 = De-Humidify (Direct)

DEHUMIDIFICATION USING COOLING

In addition the controller has dehumidification function where the corresponding zone multi-stage temperature control Cooling Stage 2 is overridden to 100% when the dehumidification demand is 50% (and the Humidity Interlock function is enabled). The Cooling Stage 2 returns to automatic control after dehumidification demand drops to 0%. To control the switch on humidity and switch off humidity, it is recommended that the humidity PI-control loop is set to operate in P-mode (set Integral Action to 0 to disable it). Using this function it is possible to condition the supply air simultaneously with heat and cool (and dehumidify in the process, ref Mollier Diagram).

Parameter	Description	Value Range / Enumerations
ZONE 1 PARAMETERS		
Z1 Humidity Interlock	Enables Cooling Stage 2 Interlock on High Humidity (at 50% humidity loop demand) for Zone 1 Humidity Loop	0 = Disabled (Default) 1 = Enabled
ZONE 2 PARAMETERS		
Z2 Humidity Interlock	Enables Cooling Stage 2 Interlock on High Humidity (at 50% humidity loop demand) for Zone 2 Humidity Loop	0 = Disabled (Default) 1 = Enabled

NOTE: Register 424 (Zone 1) / 2424 (Zone 2) can be used to indicate the current cooling mode status.

ZONE 1 AND ZONE 2 CONDENSATION CONTROL

In cooling systems (e.g. chilled beam) when the pipe surface temperature drops reaching the dew point, this creates a condensation risk. The TCR80 Series controller have protection logic to minimise the condensation. This can be activated by enabling 'Zone 1 Digital Cooling Disable' or 'Zone 2 Digital Cooling Disable' on the Universal Inputs. In this mode the universal input operates as volt-free digital input. When the input closes the controller switches the corresponding Zone multi-stage control loop Cooling Stage Demands to 0% until the volt-free input is off (open contact).

Alternative method is to use a resistive condensation sensor where the resistance drops when condensation occurs, and resistance increases when the sensor is dry. To activate this function set the Universal Input mode to 'Zone 1 Digital Cooling Disable' or 'Zone 2 Digital Cooling Disable'. When resistance drops approximately below 100kOhms the condensation risk is active and when the resistance increases above approx. 150kOhms, there is no condensation risk. In case of condensation risk the multi-stage Cooling Stage Outputs are set to 0%

DEW POINT CONDENSATION CONTROL

If humidity sensor is fitted (-RH option) on the TDR20/QDR20 Room Display Interfaces, the dew point temperature can be calculated by the relative humidity and temperature. The TCR80 series controllers have unique function, where the room temperature and humidity is used in calculation of the dew point temperature. This temperature is then compared to the pipe temperature (set UI1/2/3/4 to corresponding Zone Dew Point mode) and when pipe temperature is dropping closer to the dew point temperature, the cooling outputs are **proportionally limited**, until the dew point danger has dissipated. The diagram on the right illustrates the maximum cooling output as a function of Dew Point temperature and Pipe temperature (calculated by Dew Point Offset - OSdp and Dew Point Range - Rdp parameters).

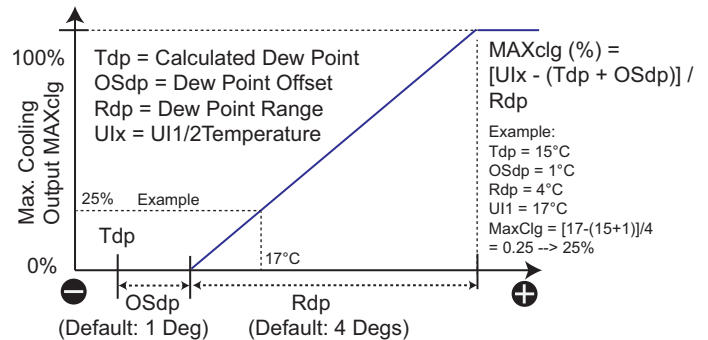

Alternatively by changing the Dew Point Mode parameter to **On/Off**, the cooling outputs are switched OFF at $Tdp + OSdp$ and return back to normal control at $Tdp + OSdp + Rdp$.

NOTE: The controller uses approximation method for the dew point temperature calculation. This only works when the relative humidity is more than 50% RH.

NOTE: It is possible to use UI measurements to calculate the Dew Point. To activate this set the Multi-Stage Control Loop Source to corresponding temperature sensor, and Humidity Control Loop Source to corresponding remote humidity sensor measurement.

Parameter	Description	Value Range / Enumerations
ZONE 1 PARAMETERS		
Z1 Dew Point Range	Z1 Dew Point calculation range where the Dew Point based cooling max. position calculates linearly from 100% to 0%	0..10 Degrees (Default 4)
Z1 Dew Point Mode	Z1 Dew Point Mode Selection	0 = On-Off 1 = Proportional (Default)
Z1 Dew Point Offset	Z1 Dew Point Offset (from the calculated Dew Point) where the Dew Point based calculated max. position is 0%	0..5.0 Degrees (Default 1.0)
ZONE 2 PARAMETERS		
Z2 Dew Point Range	Z2 Dew Point calculation range where the Dew Point based cooling max. position calculates linearly from 100% to 0%	0..10 Degrees (Default 4)
Z2 Dew Point Mode	Z2 Dew Point Mode Selection	0 = On-Off 1 = Proportional (Default)
Z2 Dew Point Offset	Z2 Dew Point Offset (from the calculated Dew Point) where the Dew Point based calculated max. position is 0%	0..5.0 Degrees (Default 1.0)

ZONE 1 AND ZONE 2 BOOST FUNCTION

The TCR80 series controller mode can be Boosted to Occupied by TDR20/QDR20 user interfaces. Please refer to TDR20/QDR20 documentation.

ZONE 1 ECONOMISER (OUTSIDE AIR FREE COOLING)

The controller has outside air Economiser function that allows the outdoor damper to be controlled by the cooling stage demand (*Economiser Source*) when the outside air temperature (*Economiser Limit Temp Source*) is below the *Economiser Limit Setpoint*. When the outside temperature exceeds the *Economiser Limit Setpoint + 2 degrees* the economiser output is set to be at the *Economiser Min Output* level.

To activate Economiser on the analogue output, set the corresponding analogue output to 29:*Economiser*.

NOTE: In the Off controller mode the economiser output is set to 0%.

Parameter	Description	Value Range / Enumerations
Ecomiser Source	Sets the Economiser Control Source (typically Cooling Stage 1)	0 = Z1_Cooling1 (Default) 1 = Z1_Cooling2 2 = Z1_Cooling3
Economiser Limit Temp Source	Temperature that the Economiser function is monitoring (typically outside air temperature sensor).	0 = None (Default) 1 = UI1-NTC10 2 = UI2-NTC10 3 = UI3-NTC10 4 = UI4-NTC10
Economiser Limit Temp	Temperature Limit for the Economiser Output to Modulate	0..2120.0 (Default 15.0)
Economiser Min. Output	Minimum Output Level for the Economiser (min. damper position)	0..1000 (Default 15)

MINIMUM DISCHARGE TEMPERATURE CONTROL

The economiser function can also monitor the Air Discharge Temperature (set *Discharge Temp Source* to activate). If the discharge temp drops below *Discharge Min Temp*, the output is reduced by the amount set in the *Discharge Limit Band*. E.g. if Discharge Limit Band is 2 degrees then if Discharge Air Temp is 2 degrees below the Discharge Min Temp, the damper position is limited to the *Economiser Min Output* level.

Parameter	Description	Value Range / Enumerations
Discharge Temp Source	Discharge Temperature to be monitored	0 = None (Default) 1 = UI1-NTC10 2 = UI2-NTC10 3 = UI3-NTC10 4 = UI4-NTC10
Discharge Min Temp	Min. Temperature Limit for Discharge Temperature	0..2120.0 (Default 15.0)
Discharge Limit Band	Discharge Limit Band (to modulate the economiser output to min. position)	0..500.0 (Default 2.0)

HEATING STAGE LOCKOUT FUNCTIONS

COMPRESSOR LOCKOUT (HEATING STAGE 1 & HEATING STAGE 2 LOCKOUT)

The controller can monitor outside air temperature (791 Economiser Limit Temp Source). If the outside air temperature drops below the Compressor OAT Limit temperature, the heating stages 1 and 2 are force to 0% (stage 1 and stage 2 outputs are switched off). The logic has 2 degrees hysteresis.

HEATING STAGE3 LOCKOUT (SUMMER LOCKOUT)

The controller can monitor outside air temperature (791 Economiser Limit Temp Source). If the outside air temperature exceeds the Htg3 Lockout Temp limit, the Heating Stage 3 is switched to 0% (switched off).

Parameter	Description	Value Range / Enumerations
Compressor Lockout Enable	Compressor Lockout (Heating Stage 1 and 2) Enable	0 = Disabled (Default) 1 = Enabled
Compressor OAT Low Limit	Temperature Limit to Switch Heating Stages 1 and 2 to 0%	0..2120.0 (Default 0)
Htg3 Lockout Enable	Heating Stage 3 Lockout Enable	0 = Disabled (Default) 1 = Enabled
Htg3 Lockout Temp	Temperature Limit to Switch Heating Stage 3 to 0%	0..2120.0 (Default 15.0)

AVERAGE FUNCTION

Average Function can be used to average multiple measurements, and then use this value in the Z1 and Z2 control logic.

Parameter	Description	Value Range / Enumerations
Measurement 1	Sets the Source for Average Measurement 1.	0 = Disabled (Default) 1 = UI1 2 = UI2 3 = UI3 4 = UI4 5 = Z1 Temperature 6 = Z2 Temperature
Measurement 2	Sets the Source for Average Measurement 2.	
Measurement 3	Sets the Source for Average Measurement 3.	
Measurement 4	Sets the Source for Average Measurement 4. NOTE: Options 1-4 use Register 460-463 values allowing averaging to be done both NTC10 and voltage.	

OUTPUT EXERCISE FUNCTION

The TCR80 series controllers have Valve Exercise function that allows each of the outputs (Analogue, Digital) to be exercised automatically in case of inactivity (meaning output remains at 0% or 100% for the specified time). The inactivity setting can be set between 1..15 days.

Parameter	Description	Value Range / Enumerations
Valve Exercise Period	Sets the period of inactivity to activate the corresponding output.	0..15 days (Default 14 days)
Y1 Exercise Time	Analogue Output 1 Exercise Time. After configured period of inactivity, the output is driven to 50% for the Y1 Exercise Time	0..15 Minutes (Default: 0) 0 = Disabled

Y2 Exercise Time	Analogue Output 2 Exercise Time. After configured period of inactivity, the output is driven to 50% for the Y2 Exercise Time	0..15 Minutes (Default: 0) 0 = Disabled
Y2 Exercise Time	Analogue Output 3 Exercise Time. After configured period of inactivity, the output is driven to 50% for the Y3 Exercise Time	0..15 Minutes (Default: 0) 0 = Disabled
Y2 Exercise Time	Analogue Output 4 Exercise Time. After configured period of inactivity, the output is driven to 50% for the Y4 Exercise Time	0..15 Minutes (Default: 0) 0 = Disabled
TR1 Exercise Time	Triac Output 1 Exercise Time. After configured period of inactivity, the output is driven to opposite state for the TR1 Exercise Time	0..15 Minutes (Default: 0) 0 = Disabled
TR2 Exercise Time	Triac Output 2 Exercise Time. After configured period of inactivity, the output is driven to opposite state for the TR2 Exercise Time	0..15 Minutes (Default: 0) 0 = Disabled
TR3 Exercise Time	Triac Output 3 Exercise Time. After configured period of inactivity, the output is driven to opposite state for the TR3 Exercise Time	0..15 Minutes (Default: 0) 0 = Disabled
TR4 Exercise Time	Triac Output 4 Exercise Time. After configured period of inactivity, the output is driven to opposite state for the TR4 Exercise Time	0..15 Minutes (Default: 0) 0 = Disabled

Universal Input Configuration

Universal Input can be configured to operate as NCT10 (resistive), Dew Point Sensor, Analogue (0..10V), Condensation Sensor (Resistive) or Digital On/Off. Configure and wire inputs as required by the application operation using the diagram as guidance.

NTC10: Use this option to measure temperature using NTC10 temperature sensors. For control loops to use NTC10, select NTC10 in the control loop source parameters.

Z1/Z2 Dew Point Sensor: Uses the NTC10 Sensor for Dew Point Calculation Logic for the selected zone.

Resistive - kOhms : Measures the input resistance in kOhms (used e.g. for leak detection sensors) - measurement available over network. Note: the measurement resolution is 0.1 kOhms

Digital Modes: Select as appropriate to override the controller operation modes.

Condensation Sensor Option: Uses resistive condensation sensor.

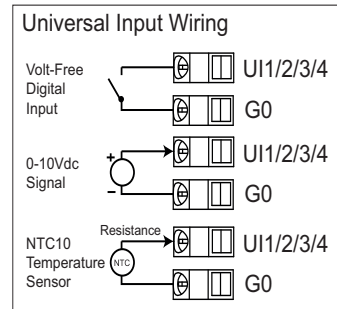

Parameter	Description	Value Range / Enumerations
UI1 Mode	Sets the Universal Input 1 Mode.	0 = Not Used 1 = 0..10V (0..100%) 2 = NTC10 (Default) 3 = Z1 Dew Point (NTC10) 4 = Z2 Dew Point (NTC10) 5 = Digital - Network 6 = Digital - Z1 Disable Cooling / Resistive Condensation Sensor 7 = Digital - Z2 Disable Cooling / Resistive Condensation Sensor 8 = Digital - Z1 Occupied 9 = Digital - Z1 Unoccupied 10 = Digital -Z1 Off 11 = Digital -Z1 Unocc/Occ 12 = Digital -Z1 Off / Occ 13 = Digital -Z2 Occupied 14 = Digital -Z2 Unoccupied 15 = Digital -Z2 Off 16 = Digital -Z2 Unocc / Occ 17 = Digital -Z2 Off / Occ 18 = Resistive - kOhms
UI2 Mode	Sets the Universal Input 2 Mode.	
UI3 Mode	Sets the Universal Input 3 Mode.	
UI4 Mode	Sets the Universal Input 4 Mode. Note: Options 8,9,10, 13, 14 and 15 override to selected controller mode on OFF to ON transition. Note: Option 11/16 overrides to Occupied Mode on ON transition and Unoccupied Mode on OFF transition. Note: Option 12/17 overrides to Occupied Mode on ON transition and Off Mode on OFF transition. Note: When setting Universal Input to Digital modes, reset (apply changes) is required after the change to activate the correct state.	
UI1 Scale Min.	Sets the scaling for Min. Measurement when UI1 @ 0V (0%)	0.0..3000.0 (Default 0)
UI1 Scale Max.	Sets scaling for the Max. Measurement when UI1 @ 10V (100%)	0.0..3000.0 (Default 100.0)
UI2 Scale Min.	Sets the scaling for Min. Measurement when UI2 @ 0V (0%)	0.0..3000.0 (Default 0)
UI2 Scale Max.	Sets scaling for the Max. Measurement when UI2 @ 10V (100%)	0.0..3000.0 (Default 100.0)
UI3 Scale Min.	Sets the scaling for Min. Measurement when UI3 @ 0V (0%)	0.0..3000.0 (Default 0)
UI3 Scale Max.	Sets scaling for the Max. Measurement when UI3 @ 10V (100%)	0.0..3000.0 (Default 100.0)
UI4 Scale Min.	Sets the scaling for Min. Measurement when UI4 @ 0V (0%)	0.0..3000.0 (Default 0)
UI4 Scale Max.	Sets scaling for the Max. Measurement when UI4 @ 10V (100%)	0.0..3000.0 (Default 100.0)
UI1 Voltage Filter	UI1 Voltage Input Mode Filter Time Constant	0..255 (Default 30s)
UI2 Voltage Filter	UI2 Voltage Input Mode Filter Time Constant	0..255 (Default 30s)

UI3 Voltage Filter	UI3 Voltage Input Mode Filter Time Constant	0..255 (Default 30s)
UI4 Voltage Filter	UI4 Voltage Input Mode Filter Time Constant	0..255 (Default 30s)

UI1/UI2/UI3/UI4 Input Minimum and Maximum scaling parameters are used to scale 0..10V signal to the measurement. E.g. typical humidity transmitters scaled 0..100%rH measurement to 0..10V on their output. In this case set the *Scale Min.* parameter to 0 and *Scale Max.* parameter to 100.

In case of CO2 transmitter, these scale the 400..2,000ppm reading to 0..10V. In this case set the *Scale Min.* parameter to 400 and *Scale Max.* parameter to 2,000. Other example, if the CO2 transmitter uses range 0..5,000ppm, set *UI Scale Max.* to 3,000 and *UI Voltage Max* to 6V. This scales input to operate 0..6V = 0..3,000ppm.

NOTE: Using the scaling it is possible also connect pressure sensors to the controller. The controllers have also advanced UI1/UI2/UI3/UI4 voltage clamping settings that can be used to scale e.g. input voltage for e.g. 0..10V = 0..5000ppm CO2 sensors.

NOTE: UI1/2/3/4 Voltage Filter Time Constant can be used to control the speed of measurement whne the universal input is used in the 0-10V mode. Longer the time constant, slower the response time (noise is filtered out).

Analogue Output and Valve Control Options

0 - 10V OUTPUT CONFIGURATION AND SCALING

The Y1/Y2/Y3/Y4 0..10V outputs can be configured to control based on the options in the below table. In addition each output can be scaled between minimum and maximum limits. Reversing the limits is also possible which will reverse the output voltage (e.g. for situations where the 0..10V valve signal closes the valve instead of opening it).

TIP: By setting minimum output position it is possible e.g. set minimum fresh air level to air dampers.

NOTE: At Night Off mode the outputs switch to 0V (or 10V if reverse mode has been activated) for the corresponding Zone related outputs.

NOTE: TCR83 controllers haev 3 x 0-10Vdc analogue outputs. Output Y3 is linked to the 230V Fan Relay Control. For fan control set the Y3 Mode = Z1 Fan Demand (default).

Parameter	Description	Value Range / Enumerations
Y1 Output Mode	Y1 Output Configuration Default: Z1 Heating Stage 1	0 = Network Value 1 = Z1 Heating Stage 1 2 = Z1 Heating Stage 2 3 = Z1 Heating Stage 3 4 = Z1 Cooling Stage 1 5 = Z1 Cooling Stage 2 6 = Z1 Cooling Stage 3 7 = Z1 CO2 Demand 8 = Z1 VOC / AUX Demand 9 = Z1 Humidity/DeHum Demand 10 = Z1 Max Function 1 11 = Z1 Max Function 2 12 = Z1 Fan Demand 13 = Z1 6-Way Valve 14 = Z1 Reverse 6-Way Valve 15 = Z2 Heating Stage 1 16 = Z2 Heating Stage 2 17 = Z2 Heating Stage 3 18 = Z2 Cooling Stage 1 19 = Z2 Cooling Stage 2 20 = Z2 Cooling Stage 3 21 = Z2 CO2 Demand 22 = Z2 VOC / AUX Demand 23 = Z2 Humidity/DeHum Demand 24 = Z2 Max Function 1 25 = Z2 Max Function 2 26 = Z2 Fan Demand 27 = Z2 6-Way Valve 28 = Z2 Reverse 6-Way Valve 29 = Economiser
Y2 Output Mode	Y2 Output Configuration Default: Z1 Cooling Stage 1	
Y3 Output Mode	Y3 Output Configuration Default: Z1 Fan Speed Control	
Y4 Output Mode	Y4 Output Configuration Default: Z1 CO2 Control Note: For Modbus to override the output from the network set the mode to network. Note: For BACnet the output can be overridden using corresponding AV objects.	
Y1 Minimum	Y1 Output Minimum Level	0.0..100.0% (Default 0%)
Y1 Maximum	Y1 Output Maximum Level	0.0..100.0% (Default 100%)
Y2 Minimum	Y2 Output Minimum Level	0.0..100.0% (Default 0%)
Y2 Maximum	Y2 Output Maximum Level	0.0..100.0% (Default 100%)
Y3 Minimum	Y3 Output Minimum Level	0.0..100.0% (Default 0%)
Y3 Maximum	Y3 Output Maximum Level	0.0..100.0% (Default 100%)

Y4 Minimum	Y4 Output Minimum Level	0.0..100.0% (Default 0%)
Y4 Maximum	Y4 Output Maximum Level	0.0..100.0% (Default 100%)

6-WAY VALVE CONTROL

The 6-way valve option allows the controller to control 6-way valves that can be used for both heating and cooling control, simplifying heating/cooling coil structure. The principle of 6-way valve control is shown in the diagram. To activate the 6-way valve control the 0..10V output (Y1..Y4) is set to 'Z1 6-way valve' or 'Z2 6-way valve'. It is possible to modify the 6-way valve control parameters to suit the different 6-way valve manufacturers. The default settings are provided for Belimo 6-way valve.

Using the 'Z1 Reverse 6-Way Valve' or 'Z1 Reverse 6-Way Valve' option the Sequence 1 and Sequence 2 are swapped. This allows the controller to be configured to suit regardless of the 6-way valve piping.

The table below illustrates the switching parameters for the 6-way control. The parameters apply for both Zone 1 and Zone 2.

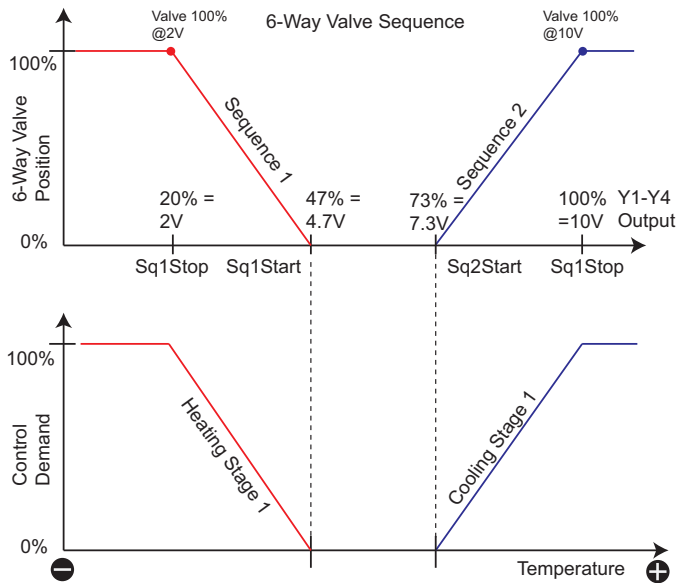

Parameter	Description	Value Range / Enumerations
Sequence 1 Start Value (Sq1Start)	6-Way Valve Sequence 1 Start Voltage. With setting '6-Way Valve' Main Loop Heating Stage 1 at 0% Demand.	0..100% (Default 47% = 4.7V)
Sequence 1 Stop Value (Sq1Stop)	6-Way Valve Sequence 1 Stop Voltage. With setting '6-Way Valve' Main Loop Heating Stage 1 at 100% Demand.	0..100% (Default 20% = 2V)
Sequence 2 Start Value (Sq2Start)	6-Way Valve Sequence 2 Start Voltage. With setting '6-Way Valve' Main Loop Cooling Stage 1 at 0% Demand.	0..100% (Default 73% = 7.3V)
Sequence 2 Stop Value (Sq2Stop)	6-Way Valve Sequence 2 Stop Voltage. With setting '6-Way Valve' Main Loop Cooling Stage 1 at 100% Demand.	0..100% (Default 100% = 10V)

3-SPEED FAN CONTROL

TCR83 controllers have 3 x 230V Fan Relays. The Y3 is inter-connected to the fan relays. Relay 1 comes on at approximately 30%, relay 2 at 65% and relay 3 at 99%. Configure Y3 to follow the Z1 Fan Speed, for the fan relays to follow the fan speed control logic. It also also recommended to set the

Digital Output Control Options

DIGITAL TRIAC OUTPUT CONTROL OPTIONS

The TCR81 series controllers have 2 x 24Vac Triac and TCR82 Series controllers have 4 x 24Vac Triac. The triacs can operate in On/Off and PWM (Pulse-Width Modulation) and 3-Point (Raise-Lower) configurations.

3-POINT MODE

If the ThreePoint1 is activated then TR1 and TR2 are used for 3-Point control (raise-lower). TR1 is used to drive the actuator open and TR2 is used to drive the actuator close. The actuator running time and run on times are adjustable.

ThreePoint2 activates the TR3 (open) and TR4 (close).

After controller reset the threepoint function drives the close triac for the run time period after which it resumes in normal operation.

NOTE: TR3 and TR4 are only available with the TCR81 Series.

PWM MODE

In the PWM mode the output is modulated using pulse-width-modulation sequence. With On/Off Mode the outputs are switched ON at 'DO On Value' and OFF at 'DO Off Value'.

Use TRs Direction parameter to reverse the PWM / ON-Off output.

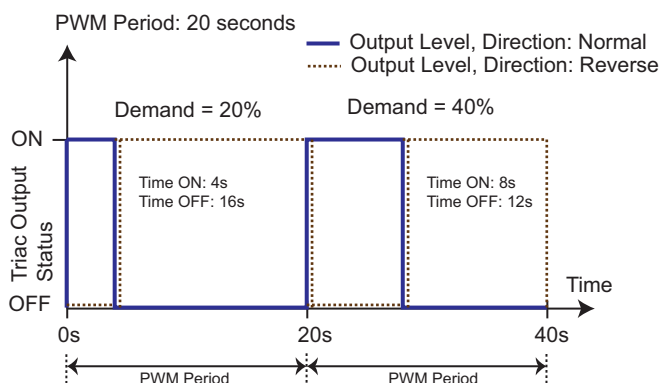

Parameter	Description	Value Range / Enumerations
ThreePoint1 Mode	Threepoint 1 Mode (=Source)	0 = None (Default) 1 = Network Value 2 = Z1 Heating Stage 1 3 = Z1 Heating Stage 2 4 = Z1 Heating Stage 3 5 = Z1 Cooling Stage 1 6 = Z1 Cooling Stage 2 7 = Z1 Cooling Stage 3 8 = Z1 CO2 Demand 9 = Z1 VOC / AUX Demand 10 = Z1 Humidity/DeHum Demand 11 = Z1 Max Function 1 12 = Z1 Max Function 2 13 = Z1 Fan Demand 14 = Z2 Heating Stage 1 15 = Z2 Heating Stage 2 16 = Z2 Heating Stage 3 17 = Z2 Cooling Stage 1 18 = Z2 Cooling Stage 2 19 = Z2 Cooling Stage 3 20 = Z2 CO2 Demand 21 = Z2 VOC / AUX Demand 22 = Z2 Humidity/DeHum Demand 23 = Z2 Max Function 1 24 = Z2 Max Function 2 25 = Z2 Fan Demand
ThreePoint2 Mode	Threepoint 2 Mode (=Source)	
ThreePoint Run Time	ThreePoint Actuator Run Time (set to match the actuator run time)	10..2400 seconds (default 90 secs)
ThreePoint RunOn Time	ThreePoint Actuator RunOn Time (overrun time when the actuator position reaches 0 or 100%)	10..240 seconds (default 10 secs)

TR1 Output Mode	Triac Output 1 Configuration Default: Z1 Heating Stage 1	0 = Network Value 1 = Z1 Heating Stage 1 2 = Z1 Heating Stage 2 3 = Z1 Heating Stage 3 4 = Z1 Cooling Stage 1 5 = Z1 Cooling Stage 2 6 = Z1 Cooling Stage 3 7 = Z1 CO2 Demand 8 = Z1 VOC / AUX Demand 9 = Z1 Humidity/DeHum Demand 10 = Z1 Max Function 1 11 = Z1 Max Function 2 12 = Z1 Fan Demand 13 = Z1 Fan Speed 1 14 = Z1 Fan Speed 2 15 = Z1 Fan Speed 3 16 = Z2 Heating Stage 1 17 = Z2 Heating Stage 2 18 = Z2 Heating Stage 3 19 = Z2 Cooling Stage 1 20 = Z2 Cooling Stage 2 21 = Z2 Cooling Stage 3 22 = Z2 CO2 Demand 23 = Z2 VOC / AUX Demand 24 = Z2 Humidity/DeHum Demand 25 = Z2 Max Function 1 26 = Z2 Max Function 2 27 = Z2 Fan Demand 28 = Z2 Fan Speed 1 29 = Z2 Fan Speed 2 30 = Z2 Fan Speed 3 31 = None 32 = Cooling Active 33 = Heating Active
TR2 Output Mode	Triac Output 2 Configuration Default: Z1 Cooling Stage 1	
TR3 Output Mode	Triac Output 3 Configuration Default: Z1 Heating Stage 2	
TR4 Output Mode	Triac Output 4 Configuration Default: Z1 Cooling Stage 2	
	Note: Outputs are controlled using either PWM or On/Off Modes (set by TRx Mode parameters). Note: With options 13-15 and 27-39, set Fan Mode = Stepped and corresponding Triac Output Type = On-Off.	
PWM Period	PWM Control Logic Period. The controller calculates the new sequence at these intervals. Setting the PWM period to 0, configures the output to operate as On/Off	0..180s (Default 20s)
DO ON Value	The value at the Triac (or Relay) Output Switches ON. Only applied whne PWM Period is set to 0.	0..100% (Default 50%)
DO OFF Value	The value at the Triac (or Relay) Output Switches OFF	0..100% (Default 0%)
TR1 Direction	Triac Output 1 Direction	0 = Normal (Default) 1 = Reverse
TR2 Direction	Triac Output 2 Direction	
TR3 Direction	Triac Output 3 Direction	
TR4 Direction	Triac Output 4 Direction	

Wireless Interfaces

BLUETOOTH WIRELESS INTERFACE

With the -BLE option the devices are fitted with integrated Bluetooth Low Energy. The Bluetooth interface provides wireless connection point to SmartPhone app to be able to interrogate and change the controller settings. Using the SmartView application the end users can change the device settings and see the current measurements. The SmartView application can be used as a complement to the display, or with non-display versions it can be used as the user interface.

LORAWAN® WIRELESS INTERFACE

With the -LRA option the devices are fitted with LoraWan® interface. The LoraWan® interface allows the devices to be connected to the LoraWan system wirelessly using Senticon's standard payload format.



The LoraWan® enabled devices will automatically connect to the network on power up. The connection attempts are staggered automatically based on the device serial number to ensure network performance on large systems. The devices will automatically send the device data (temperature, humidity, CO2, VOC etc. - see below table for default configuration) on scheduled intervals (1 to 60 minutes, default 10 minutes).

It also possible to configure the Confirmed Message Interval, Uplink Rejoin Count and disable ADR (for more details refer to Senticon's LoraWan manual and Payload Specification)

LoraWan Uplink Register	DEFAULT REGISTERS		
	Parameter	Description	TCR80 Def Reg
1 - 850	Temperature Sensor	Zone 1 TDR/QDR Sensor Temperature Measurement.	400
2 - 851	Humidity Sensor	Zone 1 TDR/QDR Humidity Measurement.	401
3 - 852	CO2 Sensor	Zone 1 TDR/QDR CO2 Reading.	402
4 - 853	VOC Sensor	Zone 1 TDR/QDR VOC (Volatile Organic Compound) Index	403
5 - 854	Temperature Sensor	Zone 2 TDR/QDR Sensor Temperature Measurement.	405
6 - 855	Humidity Sensor	Zone 2 TDR/QDR Humidity Measurement.	406
7 - 856	CO2 Sensor	Zone 2 TDR/QDR CO2 Reading.	407
8 - 857	VOC Sensor	Zone 2 TDR/QDR VOC (Volatile Organic Compound) Index	408
9 - 858	AO1	Analogue Output Y1	464
10 - 859	AO2	Analogue Output Y2	465
11 - 860	AO3	Analogue Output Y3	466
12 - 861	AO4	Analogue Output Y4	467

It is also possible to write to any parameter on the device using Senticon's packaged write message - please refer to Senticon LoraWan Payload Specification for further details.

LoraWan DownLink Register	DEFAULT REGISTERS		
	Parameter	Description	TCR80 Def Reg
1 - 862	Z1 Nominal Setpoint	Zone 1 Nominal Setpoint	701
2 - 863	Disabled	Disabled	0 - Disabled
3 - 864	Disabled	Disabled	0 - Disabled
4 - 865	Disabled	Disabled	0 - Disabled
5 - 866	Disabled	Disabled	0 - Disabled
6 - 867	Disabled	Disabled	0 - Disabled

Device Setup and Modbus/BACnet Communications

The devices are available with Modbus RTU or BACnet MS/TP communication for system integration. Please also note that the devices can be configured via Modbus or via BACnet MS/TP. Alternatively the devices can be configured locally using via PC Based Smart Config Tool or via iOS Smart Phone Application. Using any of these methods the device settings can be altered to suit the site requirements and the current device status can be interrogated.

Modbus and BACnet communication is carried out over RS485 serial network.

The Windows Smart Config Tool and iOS Smart Phone Application are connected to the device using Bluetooth dongle set (BLE-TOOLSET) that are plugged into the PC USB port and to the device (connection to device illustrated below). If the device is supplied with Built-In Bluetooth App interface (an option), then this can also be used for the tool communication connection

MODBUS / BACNET NETWORK SETUP

NOTE: Modbus RS485 or BACnet MS/TP versions are hardware specific models. It is not possible to change the communication protocol on the device. Please make sure to order the required model.

The devices can operate either as Modbus RTU RS485 slave device, or BACnet MS/TP Server. The device (slave/MAC) address and baud rate (limited) are set up using bit switches or through Windows Smart Configuration Tool / iOS Smart Phone App.

Bit switches 1-7 act as a binary decoder to set the (slave/MAC) address. Set these bit switches to OFF position if the address is configured by the software.

Bit switches 8 and 9 are used to set the baud rate. Set these bit switches to OFF position if the baud rate is configured by the software.

Bit switch EOL is used to activate 120 Ohm RS485 network End of Line termination (only used on the end of line devices).

NOTE: Default Modbus Baudrate is 9600, Parity None, 1 Stop Bit.

NOTE: Once bit switches are changed the device will automatically carry out soft reset to activate the new settings.

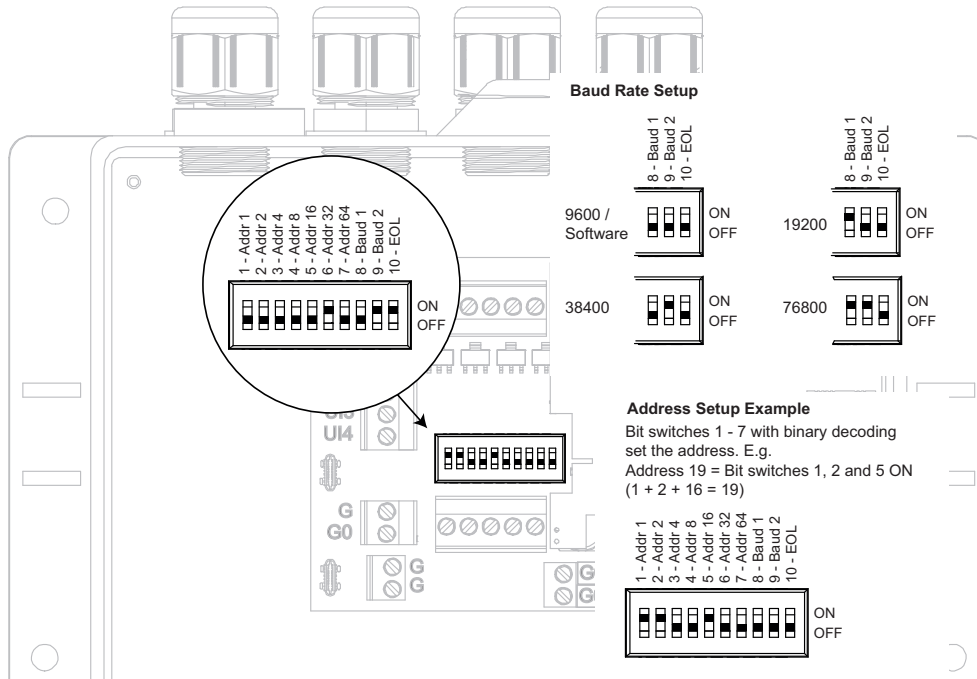

NOTE: Please note that Modbus register addresses start with 0 (0-based). If your Modbus master addresses start from one (1), then you will need to add one to the register values. If your Modbus master uses zero based addressing then the registers can be used as is.

NOTE: BACnet configuration parameter addresses are split to multiple instances of the Device Configuration object.

NOTE: Reg Field shows the Modbus register offset. The Reg field number is also the same with BACnet Device Configuration Objects.

NOTE: If the configuration parameters are changed over the Modbus or BACnet using third party tools usch as Modbus clients or Yabe for BACnet, please ensure that System Parameter 811 - Persist is applied after the configuration to store the new settings permanently.

LIVE DATA						
		MODBUS INPUT REGISTERS - FUNCTION CODE 04 MODBUS HOLDING REGISTER - FUNCTION CODES 03, (06), 16				
Parameter	Description	Reg	Type	Data Range (multiplier)	Value Range / Enumerations	R/W
ZONE MEASUREMENTS (FROM TDR20 AND QDR20 ROOM DISPLAY INTERFACES)						
Z1 Temperature	Displays current Zone 1 temperature measurement reading Note: Value depends on the temperature unit °C/°F selection	400	int16	-400..2480 (x10)	-40.0..120.0°C / -40.0..248.0°F	R
Z1 Humidity Sensor	Diplays current Zone 1 humidity measurement reading	401	uint16	0..1000 (x10)	0..100%rH	R
Z1 CO2 Sensor	Displays current measurement Zone 1 CO2 reading	402	uint16	0..10,000 (x1)	0..10,000ppm	R
Z1 VOC Sensor	Display current Zone 1 VOC Index Value	403	uint16	0..500 (x1)	0..500 index	R
Z1 Dew Point	Dew Point Temperature for Zone 1	404	int16	-400..1200 (x10)	-40.0..120.0°C	R
Z2 Temperature	Displays current Zone 2 temperature measurement reading Note: Value depends on the temperature unit °C/°F selection	405	int16	-400..2480 (x10)	-40.0..120.0°C / -40.0..248.0°F	R
Z2 Humidity Sensor	Diplays current Zone 2 humidity measurement reading	406	uint16	0..1000 (x10)	0..100%rH	R
Z2 CO2 Sensor	Displays current measurement Zone 2 CO2 reading	407	uint16	0..10,000 (x1)	0..10,000ppm	R
Z2 VOC Sensor	Display current Zone 2 VOC Index Value	408	uint16	0..500 (x1)	0..500 index	R
Z2 Dew Point	Dew Point Temperature for Zone 2	409	int16	-400..1200 (x10)	-40.0..120.0°C	R
TCR80 SERIES CONTROLLER PHYSICAL INPUTS						
Averaged Temperature	Average Temperature Calculated by the Average Function	460	int16	-400..2480 (x10)	NTC Mode: -40..120°	R
UI1	Universal Input 1 Measurement Note: Value depends on the temperature / mode selection	461	int16	-400..2480 (x10)	NTC Mode: -40..120° AI Mode: 0..100% = 0..10V kOhms Mode: 0.2..500kOhms	R
UI2	Universal Input 2 Measurement Note: Value depends on the temperature / mode selection	462	int16	-400..2480 (x10)		R
UI3	Universal Input 3 Measurement Note: Value depends on the temperature / mode selection	463	int16	-400..2480 (x10)		R
UI4	Universal Input 4 Measurement Note: Value depends on the temperature / mode selection	464	int16	-400..2480 (x10)		R
		DISCRETE INPUTS - FUNCTION CODE 02				
DI1	Digital Input 1 Status	200		0..1	0..1	R
DI2	Digital Input 2 Status	201		0..1	0..1	R
DI3	Digital Input 3 Status	202		0..1	0..1	R
DI4	Digital Input 4 Status	203		0..1	0..1	R
TCR80 SERIES CONTROLLER PHYSICAL OUTPUTS						
Y1	Analogue Output 1 Value	465	uint16	0..1000 (x10)	0..100% = 0..10V	R
Y2	Analogue Output 2 Value	466	uint16	0..1000 (x10)	0..100% = 0..10V	R
Y3	Analogue Output 3 Value	467	uint16	0..1000 (x10)	0..100% = 0..10V	R
Y4	Analogue Output 4 Value	468	uint16	0..1000 (x10)	0..100% = 0..10V	R
Triac 1 Status	Triac 1 Output Status	206		0..1	0..1	R
Triac 2 Status	Triac 2 Output Status	207		0..1	0..1	R
Triac 3 Status	Triac 3 Output Status	208		0..1	0..1	R
Triac 4 Status	Triac 4 Output Status	209		0..1	0..1	R
		MODBUS INPUT REGISTERS - FUNCTION CODE 04 MODBUS HOLDING REGISTER - FUNCTION CODES 03, 16				
Parameter	Description	Reg	Type	Data Range (multiplier)	Value Range / Enumerations	R/W
Triac 1 PWM Demand	Triac Output 1 PWM Demand (xCR11 Series) Note: For On/Off Mode shows 0% when Off and 100% when On.	470	int16	0..1000 (x10)	0..100%	R
Triac 2 PWM Demand	Triac Output 2 PWM Demand (xCR11 Series)	471	int16	0..1000 (x10)	0..100%	R
Triac 3 PWM Demand	Triac Output 3 PWM Demand (xCR11 Series)	472	int16	0..1000 (x10)	0..100%	R

Triac 4 PWM Demand	Triac Output 4 PWM Demand (xCR11 Series)	473	int16	0..1000 (x10)	0..100%	R
ThreePoint 1 Position	ThreePoint 1 Position	474	int16	0..1000 (x10)	0..100%	R
ThreePoint 2 Position	ThreePoint 2 Position	475	int16	0..1000 (x10)	0..100%	R
ThreePoint 1 Demand	ThreePoint 1 Demand	436	int16	0..1000 (x10)	0..100%	R
ThreePoint 2 Demand	ThreePoint 2 Demand	437	int16	0..1000 (x10)	0..100%	R
ZONE 1 SETPOINT AND DEMANDS						
Calculated Multi-Stage Setpoint	Z1 Calculated Setpoint for Multi-Stage Control Loop (set via Nominal Setpoint or through TDR/QDR20) Note: Read/write Modbus parameter. Writing to Reg420 sets 701 Nominal Setpoint to this value (Fw1.31).	420	int16	-32000..32000 (x10)	-3200.0..3200.0	R/W
Heating Demand	Z1 Heating Stage Demand (Multi-Loop Heating Stage 1/2/3)	421	int16	0..1000 (x10)	0..100%	R
Cooling Demand	Z1 Cooling Stage Demand (Multi-Loop Cooling Stage 1/2/3)	422	int16	0..1000 (x10)	0..100%	R
Current Control Mode	Z1 Current Control Mode Status	423	int16	0..2 (x1)	0 = Occupied 1 = Unoccupied 2 = Night	R
Cooling Status	Z1 Main Loop Cooling Stage Override Status	424	int16	0..3 (x1)	0 = Normal Operation 1 = Digital Input Disable (Condensation) 2 = Dew Point Disable (Condensation) 3 = Dehumidify (Cooling Stage 2 Overridden ON)	R
CO2 Loop Demand	Z1 CO2 Loop Demand	425	int16	0..1000 (x10)	0..100%	R
Humidity Loop Demand	Z1 Humidity Control Loop Demand	426	int16	0..1000 (x10)	0..100%	R
VOC / AUX Loop Demand	Z1 VOC / AUX Control Loop Demand	427	int16	0..1000 (x10)	0..100%	R
Fan Demand	Z1 Fan Loop Demand	428	int16	0..1000 (x10)	0..100%	R
Fan Mode	Z1 Current Fan Mode	429	int16	0..4 (x1)	0 = Off 1 = Manual Speed 1 2 = Manual Speed 2 3 = Manual Speed 3 4 = Auto	R
ZONE 2 SETPOINT AND DEMANDS						
Calculated Multi-Stage Setpoint	Z2 Calculated Setpoint for Multi-Stage Control Loop (set via Nominal Setpoint or through TDR/QDR20) Note: Read/write Modbus parameter. Writing to Reg430 sets 1701 Nominal Setpoint to this value (Fw 1.31).	430	int16	-32000..32000 (x10)	-3200.0..3200.0	R/W
Heating Demand	Z2 Heating Stage Demand (Multi-Loop Heating Stage 1/2/3)	431	int16	0..1000 (x10)	0..100%	R
Cooling Demand	Z2 Cooling Stage Demand (Multi-Loop Cooling Stage 1/2/3)	432	int16	0..1000 (x10)	0..100%	R
Current Control Mode	Z2 Current Control Mode Status	433	int16	0..2 (x1)	0 = Occupied 1 = Unoccupied 2 = Night	R
Cooling Status	Z2 Main Loop Cooling Stage Override Status	434	int16	0..3 (x1)	0 = Normal Operation 1 = Digital Input Disable (Condensation) 2 = Dew Point Disable (Condensation) 3 = Dehumidify (Cooling Stage 2 Overridden ON)	R
CO2 Loop Demand	Z2 CO2 Loop Demand	435	int16	0..1000 (x10)	0..100%	R
Humidity Loop Demand	Z2 Humidity Control Loop Demand	436	int16	0..1000 (x10)	0..100%	R
VOC / AUX Loop Demand	Z2 VOC / AUX Control Loop Demand	437	int16	0..1000 (x10)	0..100%	R
Fan Demand	Z2 Fan Loop Demand	438	int16	0..1000 (x10)	0..100%	R

Fan Mode	Z2 Current Fan Mode	439	int16	0..4 (x1)	0 = Off 1 = Manual Speed 1 2 = Manual Speed 2 3 = Manual Speed 3 4 = Auto	R
----------	---------------------	-----	-------	-----------	---	---

INPUT/OUTPUT SETTINGS						
Parameter	Description	Modbus Register / BACnet Property	MODBUS HOLDING REGISTER - FUNCTION CODES 03, 06, 16		Value Range / Enumerations	R/W
			Type	Data Range (multiplier)		
UNIVERSAL INPUTS						
UI1 Mode	<p>Sets the Universal Input 1 Mode</p> <p>Note: Options 8,9,10, 13, 14 and 15 override to selected controller mode on OFF to ON transition.</p> <p>Note: Option 11/16 overrides to Occupied Mode on ON transition and Unoccupied Mode on OFF transition.</p> <p>Note: Option 12/17 overrides to Occupied Mode on ON transition and Off Mode on OFF transition.</p> <p>Note: When setting Universal Input to Digital modes, reset (apply changes) is required after the change to activate the correct state.</p> <p>Note: Properties 500-511 available in BACnet as Config Object properties 1150-1161</p>	500 (BACnet 1150)	unit16	0..18 (x1)	0 = Not Used 1 = 0..10V (0..100%) 2 = NTC10 (Default) 3 = Z1 Dew Point (NTC10) 4 = Z2 Dew Point (NTC10) 5 = Digital - Network 6 = Digital - Z1 Disable Cooling / Resistive Condensation Sensor 7 = Digital - Z2 Disable Cooling / Resistive Condensation Sensor 8 = Digital - Z1 Occupied 9 = Digital - Z1 Unoccupied 10 = Digital -Z1 Off 11 = Digital -Z1 Unocc/Occ 12 = Digital -Z1 Off / Occ 13 = Digital -Z2 Occupied 14 = Digital -Z2 Unoccupied 15 = Digital -Z2 Off 16 = Digital -Z2 Unocc / Occ 17 = Digital -Z2 Off / Occ 18 = Resistive kOhms	R/W
UI1 Voltage Min.	Sets Min. Clamp Voltage for UI1.	501 (1151)	unit16	0..100 (x10)	0..10.0 (Default 0)	R/W
UI1 Voltage Max.	Sets Max. Clamp Voltage for UI1. Use only if the connected device upper range is more than 3000.	502 (1152)	unit16	0..100 (x10)	0..10.0 (Default 10.0)	R/W
UI1 Scale Min.	Sets the scaling for Min. Measurement when UI1 @ 0V (0%)	503 (1153)	unit16	0..30000 (x10)	0.0..3000.0 (Default 0)	R/W
UI1 Scale Max.	Sets scaling for the Max. Measurement when UI1 @ 10V (100%)	504 (1154)	unit16	0..30000 (x10)	0.0..3000.0 (Default 100.0)	R/W
UI1 Temperature Offset	UI1 Temperature Single Point Sensor Calibration Offset Note: Only applies when UI Mode = NTC10	505 (1155)	int16	-100..100 (x10)	-10.0..+10.0deg (Default 0)	R/W
UI1 Voltage Filter	UI1 Voltage Input Mode Filter Time Constant (from Fw1.31)	650	uint16	0..255 (x1)	0..255 (Default 30s)	R/W
UI2 Mode	Sets the Universal Input 2 Mode.	506 (1156)	unit16	0..17 (x1)	See UI1 Mode for Enumerations	R/W
UI2 Voltage Min.	Sets Min. Clamp Voltage for UI2. Advanced Setting.	507 (1157)	unit16	0..100 (x10)	0..10.0 (Default 0)	R/W
UI2 Voltage Max.	Sets Max. Clamp Voltage for UI2. Use only if the connected device upper range is more than 3000.	508 (1158)	unit16	0..100 (x10)	0..10.0 (Default 10.0)	R/W
UI2 Scale Min.	Sets the scaling for Min. Measurement when UI2 @ 0V (0%)	509 (1159)	unit16	0..30000 (x10)	0.0..3000.0 (Default 0)	R/W
UI2 Scale Max.	Sets scaling for the Max. Measurement when UI2 @ 10V (100%)	510 (1160)	unit16	0..30000 (x10)	0.0..3000.0 (Default 100.0)	R/W
UI2 Temperature Offset	UI2 Temperature Single Point Sensor Calibration Offset	511 (1161)	int16	-100..100 (x10)	-10.0..+10.0deg (Default 0)	R/W
UI2 Voltage Filter	UI2 Voltage Input Mode Filter Time Constant (from Fw1.31)	651	uint16	0..255 (x1)	0..255 (Default 30s)	R/W
UI3 Mode	Sets the Universal Input 3 Mode.	512	unit16	0..17 (x1)	See UI1 Mode for Enumerations	R/W

UI3 Voltage Min.	Sets Min. Clamp Voltage for UI3.	513	unit16	0..100 (x10)	0..10.0 (Default 0)	R/W
UI3 Voltage Max.	Sets Max. Clamp Voltage for UI3. Use only if the connected device upper range is more than 3000.	514	unit16	0..100 (x10)	0..10.0 (Default 10.0)	R/W
UI3 Scale Min.	Sets the scaling for Min. Measurement when UI3 @ 0V (0%)	515	unit16	0..30000 (x10)	0.0..3000.0 (Default 0)	R/W
UI3 Scale Max.	Sets scaling for the Max. Measurement when UI3 @ 10V (100%)	516	unit16	0..30000 (x10)	0.0..3000.0 (Default 100.0)	R/W
UI3 Temperature Offset	UI3 Temperature Single Point Sensor Calibration Offset	517	int16	-100..100 (x10)	-10.0..+10.0deg (Default 0)	R/W
UI3 Voltage Filter	UI3 Voltage Input Mode Filter Time Constant (from Fw1.31)	652	uint16	0..255 (x1)	0..255 (Default 30s)	R/W
UI4 Mode	Sets the Universal Input 4 Mode.	518	unit16	0..17 (x1)	See UI1 Mode for Enumerations	R/W
UI4 Voltage Min.	Sets Min. Clamp Voltage for UI4. Advanced Setting.	519	unit16	0..100 (x10)	0..10.0 (Default 0)	R/W
UI4 Voltage Max.	Sets Max. Clamp Voltage for UI4. Use only if the connected device upper range is more than 3000.	520	unit16	0..100 (x10)	0..10.0 (Default 10.0)	R/W
UI4 Scale Min.	Sets the scaling for Min. Measurement when UI4 @ 0V (0%)	521	unit16	0..30000 (x10)	0.0..3000.0 (Default 0)	R/W
UI4 Scale Max.	Sets scaling for the Max. Measurement when UI4 @ 10V (100%)	522	unit16	0..30000 (x10)	0.0..3000.0 (Default 100.0)	R/W
UI4 Temperature Offset	UI4 Temperature Single Point Sensor Calibration Offset	523	int16	-100..100 (x10)	-10.0..+10.0deg (Default 0)	R/W
UI4 Voltage Filter	UI3 Voltage Input Mode Filter Time Constant (from Fw1.31)	653	uint16	0..255 (x1)	0..255 (Default 30s)	R/W
Temperature Units	Sets the temperature measurement and display to operate in Celcius or Fahrenheit. Note: To show Fahrenheit on display set the correct Unit setting on the display.	524	unit16	0..1 (x1)	0 = Celcius (Default) 1 = Fahrenheit	R/W

ANALOGUE OUTPUTS

Y1 Mode	Y1 Output Configuration Default: Heating Stage 1 Note: For Modus to override the output from the network set the mode to network. Note: For BACnet the output can be overridden using corresponding AV objects.	530	unit16	0..29 (x1)	0 = Network Value 1 = Z1 Heating Stage 1 2 = Z1 Heating Stage 2 3 = Z1 Heating Stage 3 4 = Z1 Cooling Stage 1 5 = Z1 Cooling Stage 2 6 = Z1 Cooling Stage 3 7 = Z1 CO2 Demand 8 = Z1 VOC/AUX Demand 9 = Z1 Humidity Demand 10 = Z1 Max Function 1 11 = Z1 Max Function 2 12 = Z1 Fan Demand 13 = Z1 6-Way Valve 14 = Z1 Reverse 6-Way Valve 15 = Z2 Heating Stage 1 16 = Z2 Heating Stage 2 17 = Z2 Heating Stage 3 18 = Z2 Cooling Stage 1 19 = Z2 Cooling Stage 2 20 = Z2 Cooling Stage 3 21 = Z2 CO2 Demand 22 = Z2 VOC/AUX Demand 23 = Z2 Humidity Demand 24 = Z2 Max Function 1 25 = Z2 Max Function 2 26 = Z2 Fan Demand 27 = Z2 6-Way Valve 28 = Z2 Reverse 6-Way Valve 29 = Economiser	R/W
Y1 Override	Analogue Output Y1 Override Value	531	unit16	0..1000 (x10)	0.0..100.0% (Default 0)	R/W
Y1 Minimum	Y1 Output Minimum Level	532	unit16	0..1000 (x10)	0.0..100.0% (Default 0%)	R/W
Y1 Maximum	Y1 Output Maximum Level	533	unit16	0..1000 (x10)	0.0..100.0% (Default 100%)	R/W
Y2 Mode	Y2 Output Configuration Default: Cooling Stage 1	534	unit16	0..29 (x1)	See Y1 Mode for Enumerations	R/W
Y2 Override	Analogue Output Y2 Override Value	535	unit16	0..1000 (x10)	0.0..100.0% (Default 0)	R/W
Y2 Minimum	Y2 Output Minimum Level	536	unit16	0..1000 (x10)	0.0..100.0% (Default 0%)	R/W
Y2 Maximum	Y2 Output Maximum Level	537	unit16	0..1000 (x10)	0.0..100.0% (Default 100%)	R/W

Y3 Mode	Y3 Output Configuration Default: Fan Speed Control	538	uint16	0..29 (x1)	See Y1 Mode for Enumerations	R/W
Y3 Override	Analogue Output Y3 Override Value	539	uint16	0..1000 (x10)	0.0..100.0% (Default 0)	R/W
Y3 Minimum	Y3 Output Minimum Level	540	uint16	0..1000 (x10)	0.0..100.0% (Default 0%)	R/W
Y3 Maximum	Y3 Output Maximum Level	541	uint16	0..1000 (x10)	0.0..100.0% (Default 100%)	R/W
Y4 Mode	Y4 Output Configuration Default: CO2 Control	542	uint16	0..29 (x1)	See Y1 Mode for Enumerations	R/W
Y4 Override	Analogue Output Y4 Override Value	543	uint16	0..1000 (x10)	0.0..100.0% (Default 0)	R/W
Y4 Minimum	Y4 Output Minimum Level	544	uint16	0..1000 (x10)	0.0..100.0% (Default 0%)	R/W
Y4 Maximum	Y4 Output Maximum Level	545	uint16	0..1000 (x10)	0.0..100.0% (Default 100%)	R/W
Sequence 1 Start Value (Sq1Start)	6-Way Valve Sequence 1 Start Voltage. With setting '6-Way Valve' Main Loop Heating Stage 1 at 0% Demand.	546	uint16	0..100 (x10)	0..100% (Default 47%)	R/W
Sequence 1 Stop Value (Sq1Stop)	6-Way Valve Sequence 1 Stop Voltage. With setting '6-Way Valve' Main Loop Heating Stage 1 at 100% Demand.	547	uint16	0..100 (x10)	0..100% (Default 20%)	R/W
Sequence 2 Start Value (Sq2Start)	6-Way Valve Sequence 2 Start Voltage. With setting '6-Way Valve' Main Loop Cooling Stage 1 at 0% Demand.	548	uint16	0..100 (x10)	0..100% (Default 73%)	R/W
Sequence 2 Stop Value (Sq2Stop)	6-Way Valve Sequence 2 Stop Voltage. With setting '6-Way Valve' Main Loop Cooling Stage 1 at 100% Demand.	549	uint16	0..100 (x10)	0..100% (Default 100%)	R/W

DIGITAL INPUT SETTINGS

Digital Input 1 Off Delay	Delay Off Timer for the Universal Input 1 in Digital Input Mode	555	uint16	0..28,800 (x1)	0..28,800 seconds (default 0 secs)	R/W
Digital Input 1 Polarity	UI1 Digital Input Polarity Setting - allows the polarity of the input operation to be reversed when used in digital modes.	556	uint16	0..1 (x1)	0 = Normal (Default) 1 = Reverse	R/W
Digital Input 2 Off Delay	Delay Off Timer for the Universal Input 2 in Digital Input Mode	557	uint16	0..28,800 (x1)	0..28,800 seconds (default 0 secs)	R/W
Digital Input 2 Polarity	UI2 Digital Input Polarity Setting - allows the polarity of the input operation to be reversed when used in digital modes.	558	uint16	0..1 (x1)	0 = Normal (Default) 1 = Reverse	R/W
Digital Input 3 Off Delay	Delay Off Timer for the Universal Input 3 in Digital Input Mode	559	uint16	0..28,800 (x1)	0..28,800 seconds (default 0 secs)	R/W
Digital Input 3 Polarity	UI3 Digital Input Polarity Setting - allows the polarity of the input operation to be reversed when used in digital modes.	560	uint16	0..1 (x1)	0 = Normal (Default) 1 = Reverse	R/W
Digital Input 4 Off Delay	Delay Off Timer for the Universal Input 4 in Digital Input Mode	561	uint16	0..28,800 (x1)	0..28,800 seconds (default 0 secs)	R/W
Digital Input 4 Polarity	UI4 Digital Input Polarity Setting - allows the polarity of the input operation to be reversed when used in digital modes.	562	uint16	0..1 (x1)	0 = Normal (Default) 1 = Reverse	R/W

DIGITAL OUTPUT SETTINGS

ThreePoint1 Mode	Threepoint 1 Mode (=Source)	566	uint16	0..25 (x1)	0 = None (Default) 1 = Network Value	R/W
ThreePoint2 Mode	Threepoint 2 Mode (=Source)	567	uint16	0..25 (x1)	2 = Z1 Heating Stage 1 3 = Z1 Heating Stage 2 4 = Z1 Heating Stage 3 5 = Z1 Cooling Stage 1 6 = Z1 Cooling Stage 2 7 = Z1 Cooling Stage 3 8 = Z1 CO2 Demand 9 = Z1 VOC/AUX Demand 10 = Z1 Humidity Demand 11 = Z1 Max Function 1 12 = Z1 Max Function 2 13 = Z1 Fan Demand 14 = Z2 Heating Stage 1 15 = Z2 Heating Stage 2 16 = Z2 Heating Stage 3 17 = Z2 Cooling Stage 1 18 = Z2 Cooling Stage 2 19 = Z2 Cooling Stage 3 20 = Z2 CO2 Demand 21 = Z2 VOC/AUX Demand 22 = Z2 Humidity Demand 23 = Z2 Max Function 1 24 = Z2 Max Function 2 25 = Z2 Fan Demand	R/W

ThreePoint Run Time	ThreePoint Actuator Run Time (set to match the actuator run time)	568	uint16	10..2,400 (x1)	10..2400 seconds (default 90 secs)	R/W
ThreePoint RunOn Time	ThreePoint Actuator RunOn Time (overrun time when the actuator position reaches 0 or 100%)	569	uint16	10..240 (x1)	10..240 seconds (default 10 secs)	R/W
TR1 Output Mode	Triac Output 1 Configuration Default: Heating Stage 1	570	uint16	0..31 (x1)	0 = Network Value 1 = Z1 Heating Stage 1	R/W
TR2 Output Mode	Triac Output 2 Configuration Default: Cooling Stage 1	571	uint16	0..31 (x1)	2 = Z1 Heating Stage 2 3 = Z1 Heating Stage 3 4 = Z1 Cooling Stage 1	R/W
TR3 Output Mode	Triac Output 3 Configuration Default: Heating Stage 2	572	uint16	0..31 (x1)	5 = Z1 Cooling Stage 2 6 = Z1 Cooling Stage 3	R/W
TR4 Output Mode	Triac Output 4 Configuration Default: Cooling Stage 2 Note: Outputs are controlled using either PWM or On/Off Modes (set by TRx Mode parameters). Note: With options 12-14 and 27-39, set Fan Mode = Stepped and corresponding Triac Output Type = On-Off.	573	uint16	0..33 (x1)	7 = Z1 CO2 Demand 8 = Z1 VOC/AUX Demand 9 = Z1 Humidity/DeHum Demand 10 = Z1 Max Function 1 11 = Z1 Max Function 2 12 = Z1 Fan Demand 13 = Z1 Fan Speed 1 14 = Z1 Fan Speed 2 15 = Z1 Fan Speed 3 16 = Z2 Heating Stage 1 17 = Z2 Heating Stage 2 18 = Z2 Heating Stage 3 19 = Z2 Cooling Stage 1 20 = Z2 Cooling Stage 2 21 = Z2 Cooling Stage 3 22 = Z2 CO2 Demand 23 = Z2 VOC/AUX Demand 24 = Z2 Humidity/DeHum Demand 25 = Z2 Max Function 1 26 = Z2 Max Function 2 27 = Z2 Fan Demand 28 = Z2 Fan Speed 1 29 = Z2 Fan Speed 2 30 = Z2 Fan Speed 3 31 = None 32 = Cooling Active 33 = Heating Active	R/W
PWM Period	PWM Control Logic Period. The controller calculates the new sequence at these intervals.	574	uint16	0..180 (x1)	0..180s (Default 20s)	R/W
DO ON Value	The value at the Triac (or Relay) Output Switches ON	575	unit16	0..100 (x1)	0..100% (Default 50%)	
DO OFF Value	The value at the Triac (or Relay) Output Switches OFF	576	unit16	0..100 (x1)	0..100% (Default 0%)	R/W
TR1 Direction	Triac Output 1 Direction	577	uint16	0..1 (x1)	0 = Normal (Default) 1 = Reverse	R/W
TR2 Direction	Triac Output 2 Direction	578	uint16	0..1 (x1)	0 = Normal (Default) 1 = Reverse	R/W
TR3 Direction	Triac Output 3 Direction	579	uint16	0..1 (x1)	0 = Normal (Default) 1 = Reverse	R/W
TR4 Direction	Triac Output 4 Direction	580	uint16	0..1 (x1)	0 = Normal (Default) 1 = Reverse	R/W
Triac 1 / ThreePoint 1 Level Override	Triac 1 Output (PWM) Network Override or 3-Point Actuator Override Level Note: Set output to Network	583	uint16	0..100 (x1)	PWM: 0% = OFF (default) 100% = ON	R/W
Triac 2 Level Override	Triac 2 Output (PWM) Network Override Note: Set output to Network	584	uint16	0..100 (x1)	1%.99% = ON/OFF based on Pulse Width Modulation Settings	R/W
Triac 3 / ThreePoint2 Level Override	Triac 3 Output (PWM) Network Override or 3-Point Actuator Override Level Note: Set output to Network	585	uint16	0..100 (x1)	3-Point: 0..100%	R/W
Triac 4 Level Override	Triac 4 Output (PWM) Network Override Note: Set output to Network	586	uint16	0..100 (x1)		R/W
TR1 Type	Triac 1 (DO1) Output Type - On/Off or PWM	587	unit16	0..1 (x1)	0 = On/Off 1 = PWM (Default)	R/W
TR2 Type	Triac 2 (DO2) Output Type - On/Off or PWM	588	unit16	0..1 (x1)		R/W
TR3 Type	Triac 3 (DO3) Output Type - On/Off or PWM	589	unit16	0..1 (x1)		R/W
TR4 Type	Triac 4 (DO4) Output Type - On/Off or PWM	590	unit16	0..1 (x1)		R/W

Parameter	Description	Modbus Register	MODBUS HOLDING REGISTER - FUNCTION CODES 03, 06, 16		Value Range / Enumerations	R/W
			Type	Data Range (multiplier)		
COMMISSIONING OVERRIDES (Modbus Versions Only)						
Y1 Commission Override	Y1 Commissioning Override Parameter	640	uint16	0..3 (x1)	0 = Auto (Default) 1 = Manual Override 2 = 0% 3 = 100%	R/W
Y2 Commission Override	Y2 Commissioning Override Parameter	641	uint16	0..3 (x1)		R/W
Y3 Commission Override	Y3 Commissioning Override Parameter	642	uint16	0..3 (x1)		R/W
Y4 Commission Override	Y4 Commissioning Override Parameter	643	uint16	0..3 (x1)		R/W
Y1 Override	Analogue Output Y1 Override Value (used when 640 = Manual)	531	unit16	0..1000 (x10)	0.0..100.0% (Default 0)	R/W
Y2 Override	Analogue Output Y2 Override Value (used when 641 = Manual)	535	unit16	0..1000 (x10)	0.0..100.0% (Default 0)	R/W
Y3 Override	Analogue Output Y3 Override Value (used when 642 = Manual)	539	unit16	0..1000 (x10)	0.0..100.0% (Default 0)	R/W
Y4 Override	Analogue Output Y4 Override Value (used when 643 = Manual)	543	unit16	0..1000 (x10)	0.0..100.0% (Default 0)	R/W
TR1 Override	TR1 Commissioning Override Parameter	644	uint16	0..3 (x1)	0 = Auto (Default) 1 = Manual Override 2 = 0% 3 = 100%	R/W
TR2 Override	TR2 Commissioning Override Parameter	645	uint16	0..3 (x1)		R/W
TR3 Override	TR3 Commissioning Override Parameter	646	uint16	0..3 (x1)		R/W
TR4 Override	TR4 Commissioning Override Parameter	647	uint16	0..3 (x1)		R/W
Triac 1 Level Override	Triac 1 Output (PWM) Network Override (xCR11 Range Only) Note: When 694 = Manual	583	uint16	0..100 (x1)	0% = OFF (default) 100% = ON 1%.99% = ON/OFF based on Pulse Width Modulation Settings	R/W
Triac 2 Level Override	Triac 2 Output (PWM) Network Override (xCR11 Range Only) Note: When 695 = Manual	584	uint16	0..100 (x1)		R/W
Triac 3 Level Override	Triac 3 Output (PWM) Network Override (xCR11 Range Only) Note: When 696 = Manual	585	uint16	0..100 (x1)		
Triac 4 Level Override	Triac 4 Output (PWM) Network Override (xCR11 Range Only) Note: When 697 = Manual	586	uint16	0..100 (x1)		

NETWORK VALUES AND OUPUT EXERCISE						
Parameter	Description	Modbus Register / BACnet Property	MODBUS HOLDING REGISTER - FUNCTION CODES 03, 06, 16		Value Range / Enumerations	R/W
			Type	Data Range (multiplier)		
Network Value 1	Network Value 1. Used for control loop external measurements and TDR/QDR20 display functions. NOTE: This value is also automatically sent to Modbus Slave 1 Reg 538 if slave activated. TDR/QDR can display the value depending on configuration.	600	int16	-9990..9990 (x10)	-999.0..999.0 (Default 0)	R/W
Network Value 2	Network Value 2 (for displaying network integer value e.g. energy measurements) NOTE: This value is also automatically sent to Modbus Slave 1 Reg 539 if slave activated	601	uint16	0..65535 (x1)	0..65535 (Default 0)	R/W
Network Value 3	Network Value 1. Used for control loop external measurements and display functions. NOTE: This value is also automatically sent to Modbus Slave 2 Reg 538 if slave activated	602	int16	-9990..9990 (x10)	-999.0..999.0 (Default 0)	R/W
Network Value 4	Network Value 2 (for displaying network integer value e.g. energy measurements) NOTE: This value is also automatically sent to Modbus Slave 2 Reg 539 if slave activated	604	uint16	0..65535 (x1)	0..65535 (Default 0)	R/W
Valve Exercise Period	Sets the period of inactivity to activate the corresponding output.	610	uint16	0..15 (x1)	0..15 days (Default 14 days)	R/W
Y1 Exercise Time	Analogue Output 1 Exercise Time. After configured period of inactivity, the output is driven to 50% for the Y1 Exercise Time	611	uint16	0..15 (x1)	0..15 Minutes (Default: 0) 0 = Disabled	R/W

Y2 Exercise Time	Analogue Output 2 Exercise Time. After configured period of inactivity, the output is driven to 50% for the Y2 Exercise Time	612	uint16	0..15 (x1)	0..15 Minutes (Default: 0) 0 = Disabled	R/W
Y2 Exercise Time	Analogue Output 3 Exercise Time. After configured period of inactivity, the output is driven to 50% for the Y3 Exercise Time	613	uint16	0..15 (x1)	0..15 Minutes (Default: 0) 0 = Disabled	R/W
Y2 Exercise Time	Analogue Output 4 Exercise Time. After configured period of inactivity, the output is driven to 50% for the Y4 Exercise Time	614	uint16	0..15 (x1)	0..15 Minutes (Default: 0) 0 = Disabled	R/W
TR1 Exercise Time	Triac Output 1 (DO1) Exercise Time. After configured period of inactivity, the output is driven to opposite state for the TR1 Exercise Time	615	uint16	0..15 (x1)	0..15 Minutes (Default: 0) 0 = Disabled	R/W
TR2 Exercise Time	Triac Output 2 (DO2) Exercise Time. After configured period of inactivity, the output is driven to opposite state for the TR2 Exercise Time	616	uint16	0..15 (x1)	0..15 Minutes (Default: 0) 0 = Disabled	R/W
TR3 Exercise Time	Triac Output 3 (DO3) Exercise Time. After configured period of inactivity, the output is driven to opposite state for the TR3 Exercise Time	617	uint16	0..15 (x1)	0..15 Minutes (Default: 0) 0 = Disabled	R/W
TR4 Exercise Time	Triac Output 4 (DO4) Exercise Time. After configured period of inactivity, the output is driven to opposite state for the TR4 Exercise Time	618	uint16	0..15 (x1)	0..15 Minutes (Default: 0) 0 = Disabled	R/W

AVERAGE FUNCTION						
Parameter	Description	Modbus Register / BACnet Property	MODBUS HOLDING REGISTER - FUNCTION CODES 03, 06, 16		Value Range / Enumerations	R/W
			Type	Data Range (multiplier)		
Measurement 1	Measurement 1 for Average Calculation	620	uint16	0..6 (x1)	0 = Disabled (Default) 1 = UI1 2 = UI2 3 = UI3 4 = UI4 5 = Z1 Temperature 6 = Z2 Temperature	R/W
Measurement 2	Measurement 2 for Average Calculation	621	uint16	0..6 (x1)		R/W
Measurement 3	Measurement 3 for Average Calculation	622	uint16	0..6 (x1)		R/W
Measurement 4	Measurement 4 for Average Calculation NOTE: Options 1-4 use Register 460-463 values allowing averaging to be done both NTC10 and voltage	623	uint16	0..6 (x1)		R/W

ZONE 1 CONTROL SETTINGS						
Parameter	Description	Modbus Register / BACnet Property	MODBUS HOLDING REGISTER - FUNCTION CODES 03, 06, 16		Value Range / Enumerations	R/W
			Type	Data Range (multiplier)		
ZONE 1 CONTROL MODES AND OVERRIDES						
Z1 Override Control Mode	Z1 Override Current Control Mode (last transition applies e.g. if overridden from BACnet/Modbus network the user can change through the TDR/QDR20 Display - network poll)	681	uint16	0..3 (x1)	0 = Occupied 1 = Unoccupied 2 = Night 3 = No Override (Default)	R/W
ZONE 1 MULTI-STAGE CONTROL LOOP						
Loop Source	Sets the Control Source for the Z1 Multi-Stage Control Loop. Note: If UI mode is NTC, the control value is as measured. If the UI mode is 0-10V, then 0..10V is scaled to measurement according to UI Input Min/Max scaling parameters. Note: Average value is the calculation from Average Function.	700	uint16	0..10 (x1)	0 = Network Value (Reg 600) 1 = Zone Temperature (Default) 2 = UI1 - NTC10 3 = UI2 - NTC10 4 = UI3 - NTC10 5 = UI4 - NTC10 6 = UI1 - 0..10Vdc 7 = UI2 - 0..10Vdc 8 = UI3 - 0..10Vdc 9 = UI4 - 0..10Vdc 10 = Average Value	R/W
Nominal Setpoint	Z1 Control Loop Nominal Setpoint Note: The control loop setpoint can be shifted by the high/low limit (cascade) control function.	701	uint16	0..32000 (x10)	0.0..3200.0, Default 21.0	R/W
Proportional Band	Z1 Control Loop Proportional Band (for each Stage)	705	uint16	1..3200 (x1)	1..3200 (Default 5)	R/W

Integral Action Time	Z1 Control Loop Integral Action Time (Set to 0 to disable)	706	uint16	0..3600 (x1)	0..3600s (Default 600s) 0 = Disabled	R/W
No of Heating Stages	Sets the number of heating stages for Z1.	707	uint16	0..3 (x1)	0 = None 1 = 1-Stage (default)	R/W
No of Cooling Stages	Sets the number of cooling stages for Z1.	708	uint16	0..3 (x1)	2 = 2-Stages 3 = 3-Stages	R/W
Occ Heating Deadzone	Occupied Mode Heating Deadzone for Z1	709	uint16	0..300 (x10)	0.0..30.0 (Default 0.5)	R/W
Occ Cooling Deadzone	Occupied Mode Cooling Deadzone for Z1	710	uint16	0..300 (x10)	0.0..30.0 (Default 0.5)	R/W
Unocc Heating Deadzone	Unoccupied Mode Heating Deadzone for Z1	711	uint16	0..300 (x10)	0.0..30.0 (Default 3.0)	R/W
Unocc Cooling Deadzone	Unoccupied Mode Cooling Deadzone for Z1	712	uint16	0..300 (x10)	0.0..30.0 (Default 3.0)	R/W
Frost Setpoint	Off Mode Frost Setpoint for Z1	713	uint16	0..600 (x10)	0.0..60.0 (Default 10.0)	R/W

ZONE 1 CHANGE-OVER FUNCTION

Change-Over Source	Sets the Source for the Change-Over Function for Z1. Note: As default the Network Command is Off i.e. no change-over function is active.	722	uint16	0..8 (x1)	0 = Network Command (Reg 726, Default) 1 = UI1 - NTC10 2 = UI2 - NTC10 3 = UI3 - NTC10 4 = UI4 - NTC10 5 = Digital Input 1 (UI1) 6 = Digital Input 2 (UI2) 7 = Digital Input 3 (UI3) 8 = Digital Input 4 (UI4)	R/W
Change-Over Low Level	Z1 Temperature below which the change-over is active (cooling stage active). Note: Relevant only for NTC Input 1/2/3/4 options.	724	uint16	0..1000 (x10)	0..100.0° Default 18°	R/W
Change-Over High Level	Z1 Temperature above which the change-over is off (heating stage active, no override on control). Note: Relevant only for NTC Input 1/2/3/4 options.	725	uint16	0..1000 (x10)	0..100.0° Default 22°	R/W
Change-Over Override	Heating / Cooling Mode Command from Network. Note: Requires change-over source to be set as Network.	726	uint16	0..1 (x1)	0 = Heating (Default) 1 = Cooling	R/W

ZONE 1 LOW/HIGH LIMIT RESET FUNCTION

Reset Control Source	Sets the Temperature Source for the Reset Control Function for Z1. Note: Default: 5 - Disabled	727	uint16	0..5 (x1)	0 = Network Value (Reg 600) 1 = UI1 - NTC10 2 = UI2 - NTC10 3 = UI3 - NTC10 4 = UI4 - NTC10 5 = Disable (Default)	R/W
High Limit Setpoint	Z1 High Limit Setpoint. Above this limit the setpoint is reduced proportionally according to the ratio and temperature difference.	729	uint16	0..1000 (x10)	0.0..100.0° Default 35°	R/W
Low Limit Setpoint	Z1 Low Limit Setpoint. Below this limit the setpoint is increased proportionally according to the ratio and temperature difference.	730	uint16	0..1000 (x10)	0.0..100.0° Default 15°	R/W
Reset Ratio	Z1 Reset ratio used to calculated the setpoint reset.	731	uint16	0..100 (x10)	0.0..10.0 (Default 1.0)	R/W

ZONE 1 MAX FUNCTION

Max1 Source 1	Sets the Souce for Input 1 of Z1 Maximum Function 1 Default: Heating Stage 1	732	uint16	0..12 (x1)	0 = Network Value (Reg 600)	R/W
Max1 Source 2	Sets the Souce for Input 2 of Z1 Maximum Function 1 Default: Cooling Stage 1	733	uint16	0..12 (x1)	1 = Z1 Heating Stage 1 2 = Z1 Heating Stage 2 3 = Z1 Heating Stage 3	R/W
Max2 Source 1	Sets the Souce for Input 1 of Z1 Maximum Function 2 Default: Cooling Stage 1	734	uint16	0..12 (x1)	4 = Z1 Cooling Stage 1 5 = Z1 Cooling Stage 2 6 = Z1 Cooling Stage 3	R/W
Max2 Source 2	Sets the Souce for Input 2 of Z1 Maximum Function 2 Default: CO2 Demand	735	uint16	0..12 (x1)	7 = Z1 CO2 Demand 8 = Z1 VOC / AUX Demand 9 = Z1 Humidity/DeHum Demand 10 = Z1 Max Function 1 11 = Z1 Max Function 2 12 = Z1 Fan Demand	R/W

ZONE 1 FAN CONTROL

Fan Control Source	Sets the Temperature Source for the Z1 Fan Control Function.	740	uint16	0..11 (x1)	0 = Network Value (Reg 600) 1 = Z1 Heating Stage 1 2 = Z1 Heating Stage 2 3 = Z1 Heating Stage 3 4 = Z1 Cooling Stage 1 5 = Z1 Cooling Stage 2 6 = Z1 Cooling Stage 3 7 = Z1 CO2 Demand 8 = Z1 VOC / AUX Demand 9 = Z1 Humidity/DeHum Demand 10 = Z1 Max Function 1 (Default) 11 = Z1 Max Function 2	R/W
Min Fan Speed	Sets the Z1 Minimum Fan Speed for EC Fans	741	uint16	0..100 (x1)	0..100% (Default 15%)	R/W
Fan Speed 1	Sets the Z1 Fan Speed 1 for EC Fans (when source 33%)	742	uint16	0..100 (x1)	0..100% (Default 33%)	R/W
Fan Speed 2	Sets the Z1 Fan Speed 2 for EC Fans (when source 66%)	743	uint16	0..100 (x1)	0..100% (Default 66%)	R/W
Fan Speed 3	Sets the Z1 Fan Speed 3 for EC Fans (when source 99%)	744	uint16	0..100 (x1)	0..100% (Default 100%)	R/W
Fan Mode	Sets the Z1 EC Fan Mode. Continuous Mode scales the fan demand based on the source and Fan Speed 1/2/3 settings. In Stepped mode the fan speed steps according to Fan Speed 1/2/3 settings.	745	uint16	0..1 (x1)	0 = Continuous Mode (Default) 1 = Stepped Mode	R/W
Fan Off Mode	Configures if the Fan is running at minimum level or is off when the fan control demand is at 0% for Z1	746	uint16	0..1 (x1)	0 = Off (Default) 1 = Minimum Speed	R/W
Fan Off Delay	Switch OFF delay when the source demand drops to 0 (and Fan Off Mode is set to Off) for Z1.	747	uint16	0..600 (x1)	0..600 seconds (Default 0)	R/W
Fan Start-Up Delay	Z1 Fan Start-Up when the source demand increases above 0%. During the delay the fan runs at Fan Speed 1 setting.	748	uint16	0..600 (x1)	0..600 seconds (Default 10)	R/W
Fan Level Override	Z1 Current Fan Level that can be set from the network. The override value is also automatically sent to the corresponding Room Display Interface.	749	uint16	0..5	0 = Manual Off 1 = Level 1 2 = Level 2 3 = Level 3 4 = Automatic 5 = No Override	R/W
Fan Levels	Z1 Fan Levels	750	uint16	0..2	0 = 0-1-A 1 = 0-1-2-A 2 = 0-1-2-3-A	R/W
Max Auto Fan Speed	Maximum Fan Speed in Automatic Control Mode	752	uint16	0..100 (x1)	0..100% (Default 100%)	R/W
ZONE 1 AIR QUALITY CONTROL						
CO2 Control Source	Sets the Source for the CO2 Control for Zone 1 Zone CO2 Measurement is from Room Display Interface 1 (Modbus Slave 1, Reg 402) Note: If set to UI1/UI2/UI3/UI4, then 0..10V is scaled to measurement according to UI Input Min/Max scaling parameters.	760	uint16	0..5 (x1)	0 = Network Value (Reg 601) 1 = Zone CO2 Measurement (Default) 2 = UI1 - 0..10V 3 = UI2 - 0..10V 4 = UI3 - 0..10V 5 = UI4 - 0..10V	R/W
CO2 Setpoint	Z1 CO2 Control Setpoint	761	uint16	0..10000 (x1)	0..10,000 (Default 750)	R/W
CO2 Proportional Band	Z1 CO2 Control Proportional Band	762	uint16	1..10000 (x1)	1..10,000 (Default 500)	R/W
CO2 Integral Action Time	Z1 CO2 Control Integral Action Time (Set to 0 to disable)	763	uint16	0..3600 (x1)	0..3600s (Default 0s)	R/W
CO2 Setpoint Setback	CO2 Control Setpoint SetBack in Unoccupied mode	764	uint16	0..2000 (x1)	0..2,000 (Default 0)	R/W
CO2 Control Mode	CO2 Control Loop Operation Direction (from Fw 1.31)	765	uint16	0..1 (x1)	0 = Reverse 1 = Direct (Default)	R/W
VOC / AUX Control Source	Sets the Source for the VOC / AUX Control for Zone 1 Zone VOC Measurement is from Room Display Interface 1 (Modbus Slave 1, Reg 402)	770	uint16	0..5 (x1)	0 = Network Value (Reg 601) 1 = Zone VOC Measurement (Default) 2 = UI1 - 0..10V 3 = UI2 - 0..10V 4 = UI3 - 0..10V (TCR82) 5 = UI4 - 0..10V (TCR82)	R/W
VOC / AUX Setpoint	Z1 VOC / AUX Control Setpoint	771	uint16	0..5000 (x1)	0..5000 (Default 100)	R/W

VOC / AUX Proportional Band	Z1 VOC / AUX Control Proportional Band	772	uint16	1..5000 (x1)	1..5000 (Default 100)	R/W
VOC / AUX Integral Action	Z1 VOC / AUX Control Integral Action Time (Set to 0 to disable)	773	uint16	0..3600 (x1)	0..3600s (Default 0s)	R/W
Z1 VOC / AUX Control Mode	VOC/AUX Control Loop Operation Direction (from Fw1.31)	774	uint16	0..1 (x1)	0 = Reverse 1 = Direct (Default)	

ZONE 1 HUMIDITY CONTROL						
Humidity Source	Sets the Source for the Z1 Humidity Control. Zone Humidity Measurement is from Room Display Interface 1 (Modbus Slave 1, Reg 401) Note: If set to UI1/UI2/UI3/UI4, then 0..10V is scaled to measurement according to UI Input Min/Max scaling parameters	780	uint16	0..5 (x1)	0 = Network Value (Reg 600) 1 = Zone Humidity Measurement (Default) 2 = UI1 - 0..10V 3 = UI2 - 0..10V 4 = UI3 - 0..10V 5 = UI4 - 0..10V	R/W
Humidity Setpoint	Z1 Humidity Control Loop Setpoint	781	uint16	0..100 (x1)	0..100% (Default 50%)	R/W
Humidity Proportional Band	Z1 Humidity Control Proportional Band	782	uint16	1..100 (x1)	1..100% (Default 20)	R/W
Humidity Integral Action	Z1 Humidity Control Integral Action Time (Set to 0 to disable)	783	uint16	0..3600 (x1)	0..3600s (Default 0s)	R/W
Humidity Mode	Z1 Humidity Loop Control Mode Default: Humidify (Reverse)	784	uint16	0..1 (x1)	0 = Humidify (Reverse) 1 = De-Humidify (Direct)	R/W
Humidity Interlock	Z1 Enables Cooling Stage 2 Interlock on High Humidity	785	uint16	0..1 (x1)	0 = Disabled (Default) 1 = Enabled	R/W
Dew Point Range	Z1 Dew Point calculation range where the Dew Point based cooling max. position calculates linearly from 100% to 0%	786	uint16	0..10 (x1)	0..10 Degrees (Default 4)	R/W
Dew Point Mode	Z1 Dew Point Mode Selection	787	uint16	0..1 (x1)	0 = On-Off 1 = Proportional (Default)	R/W
Dew Point Offset	Z1 Dew Point Offset (from the calculated Dew Point) where the Dew Point based calculated max. position is 0%	788	uint16	0..50 (x10)	0..5.0 Degrees (Default 1.0)	R/W

ZONE 1 ECONOMISER AND DISCHARGE LOW TEMP CONTROL, COMPRESSOR AND HEATING3 LOCKOUT FUNCTIONS						
Economiser Source	Sets the Economiser Control Source (typically Cooling Stage 1)	790	uint16	0..2 (x1)	0 = Z1_Cooling1 (Default) 1 = Z1_Cooling2 2 = Z1_Cooling3	R/W
Economiser Limit Temp Source	Temperature that the Economiser function is monitoring (typically outside air temperature sensor).	791	uint16	0..4 (x1)	0 = None (Default) 1 = UI1-NTC10 2 = UI2-NTC10 3 = UI3-NTC10 4 = UI4-NTC10	R/W
Economiser Limit Temp	Temperature Limit for the Economiser Output to Modulate	792	uint16	0..2120.0 (x10)	0..212.0 (Default 60.0)	R/W
Economiser Min. Output	Minimum Output Level for the Economiser (min. damper position)	793	uint16	0..1000.0 (x10)	0..1000 (Default 15)	R/W
Discharge Temp Source	Discharge Temperature to be monitored	794	uint16	0..4 (x1)	0 = None (Default) 1 = UI1-NTC10 2 = UI2-NTC10 3 = UI3-NTC10 4 = UI4-NTC10	R/W
Discharge Min Temp	Min. Temperature Limit for Discharge Temperature	795	uint16	0..2120.0 (x10)	0..212.0 (Default 60.0)	R/W
Discharge Limit Band	Discharge Limit Band (to modulate the economiser output to min. position)	796	uint16	0..500.0 (x10)	0..50.0 (Default 2.0)	R/W
Compressor Lockout Enable	Compressor Lockout (Heating Stage 1 and 2) Enable	775	uint16	0..1 (x1)	0 = Disabled (Default) 1 = Enabled	R/W
Compressor OAT Low Limit	Temperature Limit to Switch Heating Stages 1 and 2 to 0%	776	uint16	0..2120.0 (x10)	0..212.0 (Default 25)	R/W
Htg3 Lockout Enable	Heating Stage 3 Lockout Enable	777	uint16	0..1 (x1)	0 = Disabled (Default) 1 = Enabled	R/W
Htg3 Lockout Temp	Temperature Limit to Switch Heating Stage 3 to 0%	778	uint16	0..2120.0 (x10)	0..212.0 (Default 60.0)	R/W

ZONE 2 CONTROL SETTINGS						
Parameter	Description	Modbus Register / BACnet Property	MODBUS HOLDING REGISTER - FUNCTION CODES 03, 06, 16		Value Range / Enumerations	R/W
			Type	Data Range (multiplier)		
ZONE 2 CONTROL MODES AND OVERRIDES						
Override Control Mode	Z2 Override Current Control Mode (last transition applies e.g. if overridden from BACnet/Modbus network the user can change through the TDR/QDR20 Display)	1681	uint16	0..3 (x1)	0 = Occupied 1 = Unoccupied 2 = Night 3 = No Override (Default)	R/W
ZONE 2 MULTI-STAGE CONTROL LOOP						
Main Loop Source	Sets the Control Source for the Z2 Multi-Stage Control Loop. Note: If UI mode is NTC, the control value is as measured. If the UI mode is 0-10V, then 0..10V is scaled to measurement according to UI Input Min/Max scaling parameters. Note: Average value is the calculation from Average Function.	1700	uint16	0..10 (x1)	0 = Network Value (Reg 602) 1 = Zone Temperature (Default) 2 = UI1 - NTC10 3 = UI2 - NTC10 4 = UI3 - NTC10 5 = UI4 - NTC10 6 = UI1 - 0..10Vdc 7 = UI2 - 0..10Vdc 8 = UI3 - 0..10Vdc 9 = UI4 - 0..10Vdc 10 = Average Value	R/W
Main Loop Nominal Setpoint	Z2 Control Loop Nominal Setpoint Note: The control loop setpoint can be shifted by the high/low limit (cascade) control function.	1701	uint16	0..32000 (x10)	0.0..3200.0, Default 21.0	R/W
Proportional Band	Z2 Control Loop Proportional Band (for each Stage)	1705	uint16	1..3200 (x1)	1..3200 (Default 5)	R/W
Integral Action	Z2 Control Loop Integral Action Time (Set to 0 to disable)	1706	uint16	0..3600 (x1)	0..3600s (Default 600s) 0 = Disabled	R/W
No of Heating Stages	Sets the number of heating stages for Z2.	1707	uint16	0..3 (x1)	0 = None 1 = 1-Stage (default)	R/W
No of Cooling Stages	Sets the number of cooling stages for Z2.	1708	uint16	0..3 (x1)	2 = 2-Stages 3 = 3-Stages	R/W
Occ Heating Deadzone	Occupied Mode Heating Deadzone for Z2	1709	uint16	0..300 (x10)	0.0..30.0 (Default 0.5)	R/W
Occ Cooling Deadzone	Occupied Mode Cooling Deadzone for Z2.	1710	uint16	0..300 (x10)	0.0..30.0 (Default 0.5)	R/W
Unocc Heating Deadzone	Unoccupied Mode Heating Deadzone for Z2	1711	uint16	0..300 (x10)	0.0..30.0 (Default 3.0)	R/W
Unocc Cooling Deadzone	Unoccupied Mode Cooling Deadzone for Z2	1712	uint16	0..300 (x10)	0.0..30.0 (Default 3.0)	R/W
Frost Setpoint	Off Mode Frost Setpoint for Z2	1713	uint16	0..600 (x10)	0.0..60.0 (Default 10.0)	R/W

ZONE 2 CHANGE-OVER FUNCTION						
Change-Over Source	Sets the Source for the Change-Over Function for Z2. Note: As default the Network Command is Off i.e. no change-over function is active.	1722	uint16	0..8 (x1)	0 = Network Command (Reg 1726, Default) 1 = UI1 - NTC10 2 = UI2 - NTC10 3 = UI3 - NTC10 4 = UI4 - NTC10 5 = Digital Input 1 (UI1) 6 = Digital Input 2 (UI2) 7 = Digital Input 3 (UI3) 8 = Digital Input 4 (UI4)	R/W
Change-Over Low Level	Z2 Temperature below which the change-over is active (cooling stage active). Note: Relevant only for NTC Input 1/2/3/4 options.	1724	uint16	0..1000 (x10)	0..100.0° Default 18°	R/W
Change-Over High Level	Z2 Temperature above which the change-over is off (heating stage active, no override on control). Note: Relevant only for NTC Input 1/2/3/4 options.	1725	uint16	0..1000 (x10)	0..100.0° Default 22°	R/W

Change-Over Override	Heating / Cooling Mode Command from Network. Note: Requires change-over source to be set as Network.	1726	uint16	0..1 (x1)	0 = Heating (Default) 1 = Cooling	R/W
----------------------	---	------	--------	-----------	--------------------------------------	-----

ZONE 2 LOW/HIGH LIMIT RESET FUNCTION

Reset Control Source	Sets the Temperature Source for the Reset Control Function for Z2. Note: Default: 0 - Network.	1727	uint16	0..2 (x1)	0 = Network Value (Reg 602) 1 = UI1 - NTC10 2 = UI2 - NTC10 3 = UI3 - NTC10 4 = UI4 - NTC10 5 = Disable (Default)	R/W
High Limit Setpoint	Z2 High Limit Setpoint. Above this limit the setpoint is reduced proportionally according to the ratio and temperature difference.	1729	uint16	0..1000 (x10)	0.0..100.0° Default 35°	R/W
Low Limit Setpoint	Z2 Low Limit Setpoint. Below this limit the setpoint is increased proportionally according to the ratio and temperature difference.	1730	uint16	0..1000 (x10)	0.0..100.0° Default 15°	R/W
Reset Ratio	Z2 Reset ratio used to calculated the setpoint reset.	1731	uint16	0..100 (x10)	0.0..10.0 (Default 1.0)	R/W

ZONE 2 MAX FUNCTION

Max1 Source 1	Sets the Souce for Input 1 of Z2 Maximum Function 1 Default: Heating Stage 1	1732	uint16	0..12 (x1)	0 = Network Value (Reg 602)	R/W
Max1 Source 2	Sets the Souce for Input 2 of Z2 Maximum Function 1 Default: Cooling Stage 1	1733	uint16	0..12 (x1)	1 = Z2 Heating Stage 1 2 = Z2 Heating Stage 2	R/W
Max2 Source 1	Sets the Souce for Input 1 of Z2 Maximum Function 2 Default: Cooling Stage 1	1734	uint16	0..12 (x1)	3 = Z2 Heating Stage 3 4 = Z2 Cooling Stage 1 5 = Z2 Cooling Stage 2	R/W
Max2 Source 2	Sets the Souce for Input 2 of Z2 Maximum Function 2 Default: CO2 Demand	1735	uint16	0..12 (x1)	6 = Z2 Cooling Stage 3 7 = Z2 CO2 Demand 8 = Z2 VOC Demand 9 = Z2 Humidity/DeHum Demand 10 = Z2 Max Function 1 11 = Z2 Max Function 2 12 = Z2 Fan Demand	R/W

ZONE 2 FAN CONTROL

Fan Control Source	Sets the Temperature Source for the Z2 Fan Control Function.	1740	uint16	0..11 (x1)	0 = Network Value (Reg 602) 1 = Z2 Heating Stage 1 2 = Z2 Heating Stage 2 3 = Z2 Heating Stage 3 4 = Z2 Cooling Stage 1 5 = Z2 Cooling Stage 2 6 = Z2 Cooling Stage 3 7 = Z2 CO2 Demand 8 = Z2 VOC Demand 9 = Z2 Humidity/DeHum Demand 10 = Z2 Max Function 1 (Default) 11 = Z2 Max Function 2	R/W
Min Fan Speed	Sets the Z2 Minimum Fan Speed for EC Fans	1741	uint16	0..100 (x1)	0..100% (Default 15%)	R/W
Fan Speed 1	Sets the Z2 Fan Speed 1 for EC Fans (when source 33%)	1742	uint16	0..100 (x1)	0..100% (Default 33%)	R/W
Fan Speed 2	Sets the Z2 Fan Speed 2 for EC Fans (when source 66%)	1743	uint16	0..100 (x1)	0..100% (Default 66%)	R/W
Fan Speed 3	Sets the Z2 Fan Speed 3 for EC Fans (when source 99%)	1744	uint16	0..100 (x1)	0..100% (Default 100%)	R/W
Fan Mode	Sets the Z2 EC Fan Mode. Continous Mode scales the fan demand based on the source and Fan Speed 1/2/3 settings. In Stepped mode the fan speed steps according to Fan Speed 1/2/3 settings.	1745	uint16	0..1 (x1)	0 = Continous Mode (Default) 1 = Stepped Mode	R/W
Fan Off Mode	Configures if the Fan is running at minimum level or is off when the fan control demand is at 0% fo Z2	1746	uint16	0..1 (x1)	0 = Off (Default) 1 = Minimum Speed	R/W
Fan Off Delay	Switch OFF delay when the source demand drops to 0 (and Fan Off Mode is set to Off) for Z2.	1747	uint16	0..600 (x1)	0..600 seconds (Default 0)	R/W
Fan Start-Up Delay	Z2 Fan Start-Up when the source demand increases above 0%. During the delay the fan runs at Fan Speed 1 setting.	1748	uint16	0..600 (x1)	0..600 seconds (Default 10)	R/W
Fan Level Override	Z2 Current Fan Level that can be set from the network. The value is also automatically sent to the corresponding Room Display Interface Reg 606.	1749	uint16	0..5	0 = Manual Off 1 = Level 1 2 = Level 2 3 = Level 3 4 = Automatic 5 = No Override	R/W

Fan Levels	Z2 Fan Levels	17450	uint16	0..2	0 = 0-1-A 1 = 0-1-2-A 2 = 0-1-2-3-A	R/W
Max Auto Fan Speed	Maximum Fan Speed in Automatic Control Mode	1752	uint16	0..100 (x1)	0..100% (Default 100%)	R/W

ZONE 2 AIR QUALITY CONTROL

CO2 Control Source	Sets the Source for the CO2 Control for Zone 2 Zone CO2 Measurement is from Room Display Interface 1 (Modbus Slave 2, Reg 402) Note: If set to UI1/UI2/UI3/UI4, then 0..10V is scaled to measurement according to UI Input Min/Max scaling parameters.	1760	uint16	0..5 (x1)	0 = Network Value (Reg 603) 1 = Zone CO2 Measurement (Default) 2 = UI1 - 0..10V 3 = UI2 - 0..10V 4 = UI3 - 0..10V 5 = UI4 - 0..10V	R/W
CO2 Setpoint	Z2 CO2 Control Setpoint	1761	uint16	0..10000 (x1)	0..10,000 (Default 750)	R/W
CO2 Proportional Band	Z2 CO2 Control Proportional Band	1762	uint16	1..10000 (x1)	1..10,000 (Default 500)	R/W
CO2 Integral Action	Z2 CO2 Control Integral Action Time (Set to 0 to disable)	1763	uint16	0..3600 (x1)	0..3600s (Default 0s)	R/W
CO2 Setpoint Setback	CO2 Control Setpoint SetBack in Unoccupied mode	1764	uint16	0..2000 (x1)	0..2,000 (Default 0)	R/W
CO2 Control Mode	CO2 Control Loop Operation Direction (from Fw 1.31)	1765	uint16	0..1 (x1)	0 = Reverse 1 = Direct (Default)	R/W
VOC Control Source	Sets the Source for the VOC Control for Zone 1 Zone VOC Measurement is from Room Display Interface 1 (Modbus Slave 2, Reg 402)	1770	uint16	0..5 (x1)	0 = Network Value (Reg 603) 1 = Zone VOC Measurement (Default) 2 = UI1 - 0..10V 3 = UI2 - 0..10V 4 = UI3 - 0..10V (TCR82) 5 = UI4 - 0..10V (TCR82)	R/W
VOC Setpoint	Z2 VOC Control Setpoint	1771	uint16	0..5000 (x1)	0..5000 (Default 100)	R/W
VOC Proportional Band	Z2 VOC Control Proportional Band	1772	uint16	1..5000 (x1)	1..5000 (Default 100)	R/W
VOC Integral Action	Z2 VOC Control Integral Action Time (Set to 0 to disable)	1773	uint16	0..3600 (x1)	0..3600s (Default 0s)	R/W
Z2 VOC / AUX Control Mode	VOC/AUX Control Loop Operation Direction (from Fw1.31)	1774	uint16	0..1 (x1)	0 = Reverse 1 = Direct (Default)	

ZONE 2 HUMIDITY CONTROL

Humidity Source	Sets the Source for the Z2 Humidity Control. Zone Humidity Measurement is from Room Display Interface 1 (Modbus Slave 2, Reg 401) Note: If set to UI1/UI2/UI3/UI4, then 0..10V is scaled to measurement according to UI Input Min/Max scaling parameters	1780	uint16	0..5 (x1)	0 = Network Value (Reg 602) 1 = Zone Humidity Measurement (Default) 2 = UI1 - 0..10V 3 = UI2 - 0..10V 4 = UI3 - 0..10V 5 = UI4 - 0..10V	R/W
Humidity Setpoint	Z2 Humidity Control Loop Setpoint	1781	uint16	0..100 (x1)	0..100% (Default 50%)	R/W
Humidity PB	Z2 Humidity Control Proportional Band	1782	uint16	1..100 (x1)	1..100% (Default 20)	R/W
Humidity IA	Z2 Humidity Control Integral Action Time (Set to 0 to disable)	1783	uint16	0..3600 (x1)	0..3600s (Default 0s)	R/W
Humidity Mode	Z2 Humidity Loop Control Mode Default: Humidify (Reverse)	1784	uint16	0..1 (x1)	0 = Humidify (Reverse) 1 = De-Humidify (Direct)	R/W
Humidity Interlock	Z2 Enables Cooling Stage 2 Interlock on High Humidity	1785	uint16	0..1 (x1)	0 = Disabled (Default) 1 = Enabled	R/W
Dew Point Range	Z2 Dew Point calculation range where the Dew Point based cooling max. position calculates linearly from 100% to 0%	1786	uint16	0..10 (x1)	0..10 Degrees (Default 4)	R/W
Dew Point Mode	Z2 Dew Point Mode Selection	1787	uint16	0..1 (x1)	0 = On-Off 1 = Proportional (Default)	R/W
Dew Point Offset	Z2 Dew Point Offset (from the calculated Dew Point) where the Dew Point based calculated max. position is 0%	1788	uint16	0..50 (x10)	0..5.0 Degrees (Default 1.0)	R/W

SYSTEM AND COMMUNICATION SETTINGS						
Parameter	Description	Modbus Register / BACnet Property	MODBUS HOLDING REGISTER - FUNCTION CODES 03, 06, 16		Value Range / Enumerations	
			Type	Data Range (multiplier)		
Address	Modbus Address BACnet MAC Address	800	uint16	1..247 (x1) 1..127 (x1)	Modbus: 1..247 BACnet: 1..127	
Baud Rate	Baud Rate	801	uint16	0..5	0 = 9600 (default) 1 = 19200 2 = 38400 3 = 57600 4 = 76800 5 = 115200	
Modbus Parity	Modbus Parity	802	uint16	0..2	0 = None (default) 1 = Odd 2 = Even	
Modbus Stopbits	Modbus Stopbits	803	uint16	0..1	0 = 1 Stop Bit (default) 1 = 2 Stop Bits	
Soft Reset	Soft Reset	810	uint16	0..1	0 = Normal 1 = Reset	
Persist	Persist (Store Parameters in Non-Volatile Memory after changes) NOTE: DO NOT WRITE FREQUENTLY TO THIS REGISTER. IT IS ONLY APPLIED AFTER CONFIGURATION CHANGES.	811	uint16	0..1	0 = Normal 1 = Persist	
Factory Defaults	Reload Defaults (NOTE: Resets all settings to factory defaults)	812	uint16	0..1	0 = Normal 1 = Factory Defaults	
Service Pin	Service Pin (BACnet Only)	813	uint16	0..1	0 = Normal 1 = Service Pin	
Zone 1 Sensor	Enables Zone 1 TDR20/QDR20 Sensor (Modbus Address 1)	814	uint16	0..1	0 = Disabled 1 = Enabled (Default)	
Zone 2 Sensor	Enables Zone 2 TDR20/QDR20 Sensor (Modbus Address 2)	815	uint16	0..1	0 = Disabled (Default) 1 = Enabled	
Zones Lock Override	Overrides the Zone Sensor Lock (both Zone 1 and Zone 1 - TDR20/QDR20)	608	uint16	0..2	0 = No Override 1 = Unlock Screen 2 = Lock Screen	
Firmware Version	Firmware Version	820	uint16	N/A	N/A	
Serial Number	Serial Number	821	uint16	N/A	N/A	
Date Code	Date Code	822	uint16	N/A	N/A	
Product ID	Product ID	823	uint16	N/A	N/A	
Device ID	BACnet Device ID. Set to 0 to use Automatically generated ID. Follow change with "Persist" and "Reset".	825	uint32	0..4,194,303 (x1)	0..4,194,303	

LORA AUTOMATIC PAYLOAD CONFIGURATION						
Parameter	Description	Modbus Register / BACnet Property	MODBUS HOLDING REGISTER - FUNCTION CODES 03, 06, 16		Value Range / Enumerations	R/W
			Type	Data Range (multiplier)		
Uplink Register 1	LoraWan Automatic Uplink Payload Register 1. Configure to be the register number to be read in the message. (Default: Temp)	850	uint16	1..1000 (x1)	400..1000 (Default 400)	R/W
Uplink Reg 2	LoraWan Automatic Uplink Payload Register 2 (Def: Humidity)	851	uint16	1..1000 (x1)	400..1000 (Default 401)	R/W
Uplink Reg 3	LoraWan Automatic Uplink Payload Register 3 (Def: CO2)	852	uint16	1..1000 (x1)	400..1000 (Default 402)	R/W
Uplink Reg 4	LoraWan Automatic Uplink Payload Register 4 (Def: VOC)	853	uint16	1..1000 (x1)	400..1000 (Default 403)	R/W
Uplink Reg 5	LoraWan Automatic Uplink Payload Register 5 (Def: UI1)	854	uint16	1..1000 (x1)	400..1000 (Default 405)	R/W
Uplink Reg 6	LoraWan Automatic Uplink Payload Register 6 (Def: UI2)	855	uint16	1..1000 (x1)	400..1000 (Default 406)	R/W
Uplink Reg 7	LoraWan Automatic Uplink Payload Register 7 (Def: Y1)	856	uint16	1..1000 (x1)	400..1000 (Default 407)	R/W
Uplink Reg 8	LoraWan Automatic Uplink Payload Register 8 (Def: Y2)	857	uint16	1..1000 (x1)	400..1000 (Default 408)	R/W

Uplink Reg 9	LoraWan Automatic Uplink Payload Register 9 (Def: Y3)	858	uint16	1..1000 (x1)	400..1000 (Default 464)	R/W
Uplink Reg 10	LoraWan Automatic Uplink Payload Register 10 (Def: Y4)	859	uint16	1..1000 (x1)	400..1000 (Default 465)	R/W
Uplink Reg 11	LoraWan Automatic Uplink Payload Register 11 (Def: Calc SP)	860	uint16	1..1000 (x1)	400..1000 (Default 466)	R/W
Uplink Reg 12	LoraWan Automatic Uplink Payload Register 12 (Def: Aux SP)	861	uint16	1..1000 (x1)	400..1000 (Default 467)	R/W
Write Register 1	LoraWan Packaged Write Payload Register 1. Configure to be the register number to be written. (Default: Nominal SP)	862	uint16	1..1000 (x1)	400..1000 (Default 701)	R/W
Write Register 2	LoraWan Packaged Write Payload Register 2. (Def: Aux SP)	863	uint16	1..1000 (x1)	400..1000 (Default 0)	R/W
Write Register 3	LoraWan Packaged Write Payload Register 3. (Def: None)	864	uint16	1..1000 (x1)	400..1000 (Default 0)	R/W
Write Register 4	LoraWan Packaged Write Payload Register 4. (Def: None)	865	uint16	1..1000 (x1)	400..1000 (Default 0)	R/W
Write Register 5	LoraWan Packaged Write Payload Register 5. (Def: None)	866	uint16	1..1000 (x1)	400..1000 (Default 0)	R/W
Write Register 6	LoraWan Packaged Write Payload Register 6. (Def: None)	867	uint16	1..1000 (x1)	400..1000 (Default 0)	R/W
Transmission Interval	Lora Uplink Message Transmission Interval, minutes	847	uint16	0..9 (x1)	0 = 1 min 1 = 2 min 2 = 3 min 3 = 4 min 4 = 5 min 5 = 6 min 6 = 10 min 7 = 15 min 8 = 30 min 9 = 60 min	R/W

The following registers are available with Modbus only. The registers combine two parameters to a single 16-bit (2 Bytes) Modbus register.

MODBUS SPECIFIC COMBINATION REGISTERS						
		MODBUS INPUT REGISTERS - FUNCTION CODE 04 MODBUS HOLDING REGISTER - FUNCTION CODES 03, 16				
Parameter	Description		Type	Data Range (multiplier)	Value Range / Enumerations	R/W
Y1/Y2	Combined 16-Bit Register for Outputs Y1 and Y2. E.g. Y1=0x64 (100%), Y2=0x64 (100%) Register=0x6464 (25700)	450	uint16	0..25700 (x1) 0x0000..0x6464	Byte 1:Y1 (0x00..0x64), Byte 2:Y2 (0x00..0x64)	R
Y3/Y4	Combined 16-Bit Register for Outputs Y3 and Y4	451	uint16	0..25700 (x1) 0x0000..0x6464	Byte 1: Y3 (0x00..0x64), Byte 2: Y4 (0x00..0x64)	R
Htg/Clg	Combined 16-Bit Register for Heating and Cooling Demands	452	uint16	0..25700 (x1) 0x0000..0x6464	Byte 1: Htg (0x00..0x64), Byte 2: Clg (0x00..0x64)	R
Triac1/Triac2	Combined 16-Bit Register for Triac 1 and Triac 2 Demands	453	uint16	0..25700 (x1) 0x0000..0x6464	Byte 1: Triac 1 (0x00..0x64) Byte 2: Triac 2 (0x00..0x64)	R
Triac1/Triac2	Combined 16-Bit Register for Triac 3 and Triac 4 Demands	454	uint16	0..25700 (x1) 0x0000..0x6464	Byte 1: Triac 1 (0x00..0x64) Byte 2: Triac 2 (0x00..0x64)	R
Device Status	Combined 16-Bit Register for Binary Status of the Device	455	uint16	0..25700 (x1)	Bit0 - DI1, Bit1 = DI2, Bit3 = PIR, Bit4 = Relay, Bit5= Boost, Bit6 = Screen Lock	R

Bacnet Protocol Implementation Statement (PICS) and BACnet Objects

The -BAC versions of the controllers come with BACnet MS/TP communication. The following tables describe the PICS (Protocol Implementation Conformance Statement) and BACnet Objects (Standard and Proprietary). The Proprietary Objects are used for the device configuration.

GENERAL INFORMATION	
Date:	Mar 1, 2024
Vendor Name:	Senticon Ltd
Vendor ID:	1374
Product Name:	xCR Smart Room Controller
Product Models:	TCRxx, QCRxx
Applications Software Version:	1.0
Firmware Revision:	1.0.0
BACnet Prorocol Revision	1.19
Product Description:	Smart Room Controller

BACnet Standard Device Profile:	BACnet Application Specific Controller (B-ASC)		
BACnet Interoperability Blocks Supported:	Data Sharing - ReadProperty-B (DS-RP-B) Data Sharing - ReadPropertyMultiple-B (DS-RPM-B) Data Sharing - WriteProperty-B (DS-WP-B) Data Sharing - COV-B (DS-COVU-B) Device Management - DynamicDeviceBinding-B (DM-DDB-B) Device Management - DynamicObjectBinding-B (DM-DOB-B) Device Management - DeviceCommunicationControl-B (DM-DCC-B)		
Segmentation Capability:	No		
Data Link Layer Options:	MS/TP Master; Supported Baud 9600/19200/38400/57600/76800/115200		
Device Address Binding:	No static device binding supported		
Networking Options:	None		
Character Sets Supported:	ISO 10646 (UTF-8)		
Gateway Options:	None		
Network Security Options:	Non-Secure Device		
Standard Object Types Supported:	Object Type:	Optional Properties	Writeable Properties
	Analog Value:	Description, COV Increment, Relinquish Default	Present Value COV Increment
	Binary Value:	Description, Inactive_Text, Active_Text	Present Value
	Device Object:	Description Active COV Subscriptions Max Master	Object Identifier Object Name APDU Timeout (0...60000) Number Of APDU Retries (0...10) Max Master (1...127)
<p><i>For all supported objects, device does not support CreateObject or DeleteObject.</i></p> <p><i>For Analog Value objects that are classified as read only, there is the following behavior:</i></p> <ul style="list-style-type: none"> - HVAC application overwrites the present value that has been written with the Write Property Service. - In this case, no error message will be sent. <p><i>The device application checks the ranges of the Present Value and the COV Increment of the Analog Objects. For this reason, there is the following behavior:</i></p> <ul style="list-style-type: none"> - No error message, if the limits have been exceeded - Too high values are set to the range maximum - Too small values are set to the range minimum 			

OBJECT TYPE: DEVICE OBJECT				
Object Instance	Property Identifier	Value Range	Default Value	R/W
Device[x]	Object Identifier		MAC_Address	R/W
	Object Name	32 chars max.	TCR82_XXX	R/W
	Object_Type		8	R
	System_Status		Status_Operational	R
	Vendor_Name		Senticon Ltd	R
	Vendor_Identifier		1374	R
	Model_Name		TCR81 / TCR82	R
	Firmware_Revision		1.0.0	R
	Application_Software_Version		1.0	R
	Protocol_Version		1	R
	Protocol_Revision		19	R
	Protocol_Services_Supported		See General Information	R
	Protocol_Object_Types_Supporte		See General Information	R
	Object_List		See Objects List	R
	Max_APDU_Length_Accepted		480	R
	Segmentation_Supported		No	R
	APDU_Timeout		6000 ms	R/W
	Number_Of_APDU_Retries		3	R/W
	Max_Master		127	R/W
	Device_Address_Binding			R
	Database_Revision		0	R
	Property_List			R

OBJECT TYPE: ANALOGUE VALUE						
Object Instance	Object Name	Value Range	Relinquish_Default	Units	COV Increment	R/W
AV(0)	UI1	-40.0..120.0°C / -40..248°F 0..100.0%	-	DEGREES_CELCIUS or DEGREES_FAHRENHEIT or NO_UNITS	0.0..100 Default 1.0*	R
AV(1)	UI2	-40.0..120.0°C / -40..248°F 0..100.0%	-	DEGREES_CELCIUS or DEGREES_FAHRENHEIT or NO_UNITS	0.0..100 Default 1.0*	R
AV(2)	UI3	-40.0..120.0°C / -40..248°F 0..100.0%	-	DEGREES_CELCIUS or DEGREES_FAHRENHEIT or NO_UNITS	0.0..100 Default 1.0*	R
AV(3)	UI3	-40.0..120.0°C / -40..248°F 0..100.0%	-	DEGREES_CELCIUS or DEGREES_FAHRENHEIT or NO_UNITS	0.0..100 Default 1.0*	R
AV(4)	Z1 Temperature	-40.0..120.0°C / -40.0..248.0°F	-	DEGREES_CELCIUS or DEGREES_FAHRENHEIT	0.0..100 (Default 0.5*)	R
AV(5)	Z1 Humidity	0..100.0	-	RELATIVE_HUMIDITY	0.0..100 (Default 5*)	R
AV(6)	Z1 CO2	0..10,000	-	PARTS_PER_MILLION	0.0..100 (Default 50*)	R
AV(7)	Z1 VOC	0..1,000	-	NO_UNITS	0.0..100 (Default 10*)	R
AV(8)	Z2 Temperature	-40.0..120.0°C / -40.0..248.0°F	-	DEGREES_CELCIUS or DEGREES_FAHRENHEIT	0.0..100 (Default 0.5*)	R
AV(9)	Z2 Humidity	0..100.0	-	RELATIVE_HUMIDITY	0.0..100 (Default 5*)	R
AV(10)	Z2 CO2	0..10,000	-	PARTS_PER_MILLION	0.0..100 (Default 50*)	R
AV(11)	Z2 VOC	0..1,000	-	NO_UNITS	0.0..100 (Default 10*)	R
AV(12)	Z1_Setpoint_Temp	0.0..212.0	Nonvol_Setpoint	NO_UNITS	n/a	R/W
AV(13)	Z1_Setpoint_Humidity	0..100.0	Nonvol_Setpoint	RELATIVE_HUMIDITY	n/a	R/W
AV(14)	Z1_Fan_Speed	0..4.0	Nonvol_FanSpeed	NO_UNITS	1	R/W
AV(15)	Z1_Occupancy_Mode (Occupied/Unocc/Off)	0..2.0	Nonvol_OpMode	NO_UNITS	1	R/W
AV(16)	Z2_Setpoint_Temp	0.0..212.0	Nonvol_Setpoint	NO_UNITS	n/a	R/W
AV(17)	Z2_Setpoint_Humidity	0..100.0	Nonvol_Setpoint	RELATIVE_HUMIDITY	n/a	R/W
AV(18)	Z2_Fan_Speed	0..4.0	Nonvol_FanSpeed	NO_UNITS	1	R/W
AV(19)	Z2_Occupancy_Mode (Occupied/Unocc/Off)	0..2.0	Nonvol_OpMode	NO_UNITS	1	R/W
AV(20)	Network_Decimal_1	-999.0..999.0	Nonvol_Setpoint	NO_UNITS	n/a	R/W
AV(21)	Network_Integer_1	0..65535.0	Nonvol_Setpoint	NO_UNITS	n/a	R/W
AV(22)	Network_Decimal_2	-999.0..999.0	Nonvol_Setpoint	NO_UNITS	n/a	R/W
AV(23)	Network_Integer_2	0..65535.0	Nonvol_Setpoint	NO_UNITS	n/a	R/W
AV(24)	Y1	0.0..100.0%	-	PERCENT	5	R/W
AV(25)	Y2	0.0..100.0%	-	PERCENT	5	R/W
AV(26)	Y3	0.0..100.0%	-	PERCENT	5	R/W
AV(27)	Y4	0.0..100.0%	-	PERCENT	5	R/W
AV(28)	Triac1_PWM	0..100	-	PERCENT	5	R/W
AV(29)	Triac2_PWM	0..100	-	PERCENT	5	R/W
AV(30)	Triac3_PWM	0..100	-	PERCENT	5	R/W
AV(31)	Triac4_PWM	0..100	-	PERCENT	5	R/W

NOTE: Priority Input 16 is reserved for internal value. If COV increment is set to 0.0 (default), the COV is disabled.

NOTE: AV14/AV15/AV16/AV17 override the controller and TDR/QDR20 interface. To allow changes from the TDR20/QDR20, set the Priority Inputs to 'null' after the override.

NOTE: R = Read Only, R/W = Read/Write

NOTE: On COV Increments marked with asterisk (*), the COV Increment changes are stored in non volatile memory after applying 'Persist'.

OBJECT TYPE: BINARY VALUE					
Object Instance	Object Name	Description	Present Value Range / Active - Inactive Tex	Relinquish_Default	R/W
BV(0)	DI_1	Digital Input 1 Status	0: InActive (Off) 1: Active (On)	Binary_Inactive	R
BV(1)	DI_2	Digital Input 2 Status	0: InActive (Off) 1: Active (On)	Binary_Inactive	R
BV(2)	DI_3	Digital Input 1 Status	0: InActive (Off) 1: Active (On)	Binary_Inactive	R
BV(3)	DI_4	Digital Input 2 Status	0: InActive (Off) 1: Active (On)	Binary_Inactive	R
BV(4)	Z1_Cooling_Mode	Cooling Mode Override for Heating Stage 1 (Heating/Cooling)	0: InActive (Heating) 1: Active (Cooling)	Binary_Inactive	R/W
BV(5)	Z2_Cooling_Mode	Cooling Mode Override for Heating Stage 1 (Heating/Cooling)	0: InActive (Heating) 1: Active (Cooling)	Binary_Inactive	R/W

PROPRIETARY OBJECT OBJECT NAME / TYPE: "CONFIGx" / 128
The devices have six instances of proprietary Device Configuration objects split as with the configuration tools; Cfg_Inputs, Cfg_Outputs, Cfg_Calibration, Cfg_Display, Cfg_Control_1, Cfg_Control_2, Cfg_System. The devices can be fully configured using the properties of these configuration objects. Full list of available properties are listed in the <i>Device Setup and Modbus/BACnet Communication</i> section tables.

In addition to the generic parameters, the BACnet AV and BV objects have proprietary property to enable COV (Unsubscribed COV) function. For the AV objects the COV increment can be changed from the defaults. For the BV objects data is transmitted when the state changes.

NOTE: Enabling COV increases network load as the messages are broadcasted to all devices. For efficient network performance limit the number of COV objects to minimal and configure routers to allow broadcasts only on the subnets.

BACNET COV OBJECT SETTINGS						
Parameter	Description	BACnet Property	Type	Data Range (multiplier)	Value Range / Enumerations	R/W
AVx COV	AV Object COV Enable Flag x = AV Object Number (AV0..AV11, AV14..AV15, A18..AV19)	100x	uint16	0..1(x1)	0 = COV Disabled 1 = COV Enabled	R/W
BVx COV	BV Object COV Enable Flag x = BV Object Number (BV0..BV3)	110x	uint16	0..1(x1)	0 = COV Disabled 1 = COV Enabled	R/W

Dimensions

DIMENSIONS

